

KENWOOD

MONITOR WITH DVD RECEIVER

DDX7017
DDX7047

INSTRUCTION MANUAL

Kenwood Corporation



Take the time to read through this instruction manual.

Familiarity with installation and operation procedures will help you obtain the best performance from your new DVD Receiver.

For your records

Record the serial number, found on the back of the unit, in the spaces designated on the warranty card, and in the space provided below. Refer to the model and serial numbers whenever you call upon your Kenwood dealer for information or service on the product.

Model DDX7017/DDX7047 Serial number _____

US Residence Only

Register Online

Register your Kenwood product at
www.kenwoodusa.com

Contents

Before Use	4	TV/ Video Control	36
Notes on playing MP3/WMA/JPEG/MPEG..	6	Displaying the TV Picture screen	
DDX7017/7047 Basic operations.....	8	Displaying the Easy Control Panel	
Basic Operations of Remote Controller ...	10	Displaying the TV Control screen	
About discs.....	13	Displaying the TV Menu screen	
Switching Screen Mode.....	14	Seek Mode	
Muting Audio Volume upon Reception of Phone call	15	Auto Memory	
Muting Audio Volume upon Reception of Phone call		Manual Memory	
Controlling during DVD Video, Video CD, JPEG or MPEG Playback	16	Preset Select	
Displaying the DVD/VCD/JPEG/MPEG Playback screen		Set Station Name	
Displaying the Easy Control Panel		Direct Search	
Displaying the DVD/VCD Control screen		SIRIUS Tuner Control <North American sales only>	40
DVD Disc Menu		Displaying the Easy Control Panel	
VCD Zoom Control		Displaying the SIRIUS Tuner Control screen	
Picture Control		Displaying the SIRIUS Tuner Menu	
Information Display		Channel Search	
Direct Search		Channel Memory	
CD/MP3/WMA/JPEG/MPEG/Disc Changer Play Control	22	Direct Channel Search	
Displaying the Easy Control Panel		Information Display	
Displaying the CD/MP3/WMA/JPEG/MPEG/Disc Changer Control screen		HD Radio Control <North American sales only>	44
Displaying the CD/MP3/WMA/JPEG/MPEG/Disc Changer Menu screen		Displaying the Easy Control Panel	
Set Disc Name		Displaying the HD Radio Control screen	
Select Folder (during MP3/WMA/JPEG/MPEG play)		Displaying the HD Radio Menu screen	
ID3/WMA TAG Display (during MP3/WMA play)		Seek Mode	
Disc Select (during play by disc changer)		Auto Memory	
Direct Search		Manual Memory	
Tuner Control	30	Receive Mode	
Displaying the Easy Control Panel		Title Display	
Displaying the Tuner Control screen		DAB Tuner control	48
Displaying the Tuner Menu screen		Displaying the Easy Control Panel	
Seek Mode		Displaying the DAB Tuner Control screen	
Auto Memory		Displaying the DAB Tuner Menu screen	
Manual Memory		Seek Mode	
Preset Select		Auto Ensemble Memory	
Set Station Name		Service Preset Memory	
Direct Search		Service Select	
Traffic Information		Language Filter	
Search for Program Type		Search for Program Type	
Radio Text		DAB Information	
		DAB Announcement	
		Weather Band Tuner Control	54
		Displaying the Easy Control Panel	
		Displaying the Weather Band Tuner Control screen	
		Character Entry.....	55
		How To Use the Character Entry screen	

Source Select.....	56	Sound Effects Menu.....	76
Displaying the Control screen		Sound Effects Menu.....	76
Displaying the Source Select screen		Displaying the Control screen	
Adjusting the Monitor Display Position and Quality	57	Displaying the Sound Effects Menu screen	
Displaying the Screen Control screen		Audio Control	77
Displaying the Tilt Adjust screen		Displaying the Audio Control 1 screen	
Setup Menu	58	Displaying the Audio Control 2 screen	
Setup Menu	58	Equalizer	78
Displaying the Control screen		Displaying the Equalizer screen	
Displaying the Setup Menu screen		Tone curve setup	
Audio Set Up	59	Zone Control	80
Displaying the Audio Set Up screen		Displaying the Zone Control screen	
Crossover Network Setup		Glossary.....	81
DVD Setup	61	Troubleshooting Guide	82
Displaying the DVD SETUP 1 screen		Specifications.....	86
Displaying the DVD SETUP 2 screen			
Displaying the DVD SETUP 3 screen			
Language Setup			
Parental Level Setup			
System Setup	65		
Displaying the System Set Up 1 screen			
Displaying the System Set Up 2 screen			
AV Interface	66		
Displaying the AV I/F 1 screen			
Displaying the AV I/F 2 screen			
Displaying the AV I/F 3 screen			
User Interface	68		
Displaying the User I/F 1 screen			
Displaying the User I/F 2 screen			
Touch Panel Adjustment			
Clock			
Security Code Setup			
Set Up Memory			
SIRIUS Setup <North American sales only>	73		
Displaying the SIRIUS Set Up screen			
DAB Set Up	74		
Displaying the DAB Set Up screen			
Announcement Selection			

Before Use

▲WARNING

To prevent injury or fire, take the following precautions:

- To prevent a short circuit, never put or leave any metallic objects (such as coins or metal tools) inside the unit.
- Do not touch the liquid crystal fluid if the LCD is damaged or broken due to shock. The liquid crystal fluid may be dangerous to your health or even fatal.
If the liquid crystal fluid from the LCD contacts your body or clothing, wash it off with soap immediately.

▲CAUTION

To prevent damage to the machine, take the following precautions:

- Make sure to ground the unit to a negative 12V DC power supply.
- Do not install the unit in a spot exposed to direct sunlight or excessive heat or humidity. Also avoid places with too much dust or the possibility of water splashing.
- Do not place the faceplate or the faceplate case in areas exposed to direct sunlight, excessive heat or humidity. Also avoid places with too much dust or the possibility of water splashing.
- To prevent deterioration, do not touch the terminals of the unit or faceplate with your fingers.
- Do not subject the faceplate to excessive shock, as it is a piece of precision equipment.
- When replacing a fuse, only use a new fuse with the prescribed rating. Using a fuse with the wrong rating may cause your unit to malfunction.
- Do not use your own screws. Use only the screws provided. If you use the wrong screws, you could damage the unit.
- You cannot view video pictures whilst the vehicle is moving. To enjoy TV/video pictures, find a safe place to park and engage the parking brake.

NOTE

- If you experience problems during installation, consult your Kenwood dealer.
- If the unit fails to operate properly, press the Reset button to restore factory settings.

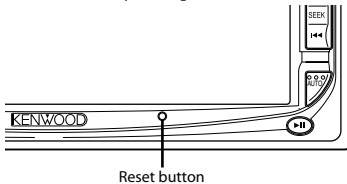

Screen brightness during low temperatures

When the temperature of the unit falls such as during winter, the liquid crystal panel's screen will become darker than usual. Normal brightness will return after using the monitor for a whilst.

Audio units you can control from the DDX7017/DDX7047 Receiver (As of June, 2005):

KTC-SR901, KTC-SR902, KTC-SR903, KTC-HR100, KTC-HR100MC, KTC-HR100TR, KHD-CX910, KHD-C710, KTC-WB100, KDC-C719, KDC-C669, KDC-C469, KDV-C810, KDC-CX89, KDC-CX87, KDC-C717, KDC-C667, KDC-C467, KDC-D301, KDC-CX85, KDC-C715, KDC-C665, KDC-C465, KDC-CX82, KDC-C712, KDC-662, KDC-D300, KMD-D400, KTC-9090DAB, KTC-V500N
(Set the "O-N" switch to "N" position if provided.)

Navigation units you can control from the DDX7017/DDX7047 Receiver (As of June, 2005):

KNA-DV2100, KNA-DV3100, KNA-DV4100

Loading and Replacing the battery

1. Use two "R03"/"AAA"-size batteries.
Slide the cover while pressing downwards to remove it as illustrated.
2. Insert the batteries with the ⊕ and ⊖ poles aligned properly, following the illustration inside the case.

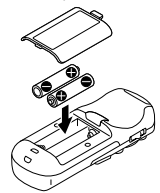

▲WARNING

Store unused batteries out of the reach of children. Contact a doctor immediately if the battery is accidentally swallowed.



- Do not set the remote control on hot places such as above the dashboard.



- The provided batteries are intended for use in operation checking, and their service life may be short.
- When the remote controllable distance becomes short, replace both of the batteries with new ones.

Cleaning the panel and monitor

When the operator panel and monitor panels are dirty, wipe and clean them using a soft cloth (such as a commercially available silicon coated cloth). When contaminated excessively, clean them using a cloth dipped in a neutral detergent first, then remove the detergent using a dry cloth. Do not use a hard cloth and a volatile chemical (such as an alcohol). If used, the panel surface may be scratched or printed letters may be erased.

Cleaning the disc slot

As dust can accumulate in the disc slot, clean it occasionally. Your discs can get scratched if you put them in a dusty disc slot.

Lens Fogging

Right after you turn on the car heater in cold weather, dew or condensation may form on the lens in the disc player of the unit. Called lens fogging, discs may be impossible to play. In such a situation, remove the disc and wait for the condensation to evaporate. If the unit still does not operate normally after a whilst, consult your Kenwood dealer.

Region codes in the world

The DVD players are given a region code according to the country or area it is marketed, as shown in the following map.

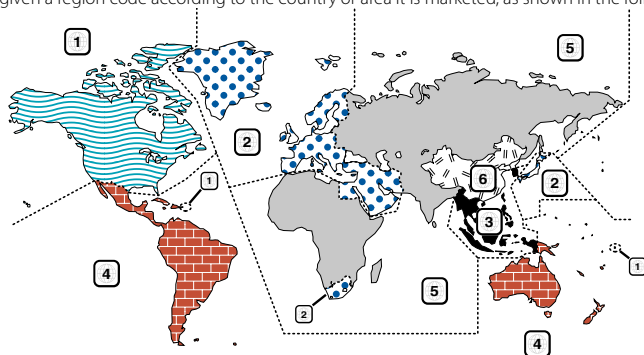

Icons on the DVD discs

Icon	Description
	Indicates the region code where the disc can be played.
	Number of voice languages recorded with the audio function. The number in the icon indicates the number of voice languages. (Max. 8 languages)
	Number of subtitle languages recorded with the subtitle function. The number in the icon indicates the number of subtitle languages. (Max. 32 languages)
	Number of angles provided by the angle function. The number in the icon indicates the number of angles. (Max. 9 angles)
	Aspect ratios that can be selected. "LB" stands for Letter Box and "PS" for Pan/Scan. In the example on the left, the 16:9 video can be converted into letter box video.

Unplayable discs

This player cannot play back any of the following discs.

- DVD-ROM/DVD-RAM discs
- CDV discs (Only the audio part can be reproduced)
- Photo CD discs
- HQ-VCD/SVCD discs
- CD-G/CD-EG/CD-EXTRA discs (Only the audio can be reproduced)
- DVD-Audio

Also, you cannot play back the DVD-R/RW and DVD+R/RW discs if not recorded in the DVD-Video format.

Restrictions due to difference between discs

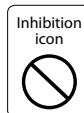

Some DVD and VCD discs can be played only in certain playback modes according to the intentions of the software producers. As this player plays discs according to their intentions, some functions may not work as intended by you. Please be sure to read the instructions provided with each disc. When an inhibition icon is displayed on the monitor, it indicates that the disc being played is under the restriction as described above.

The illustrations of the display and the panel appearing in this manual are examples used to explain more clearly how the controls are used. Therefore, what appears on the display in the illustrations may differ from what appears on the display on the actual equipment, and some of the illustrations on the display may represent something impossible in actual operation.

Explanation of icons used on this manual

- Indicates the key operation on the receiver.
- Indicates the button you must touch.
- Indicates the key or joystick operation on the remote controller.
- The initial value of each setup is shown.
- Gives an additional information or an operation advice.

Time is displayed on each control screen in the 12-hour clock display type (with AM/PM displayed) or in the 24 hour clock display type (without AM/PM displayed) depending on the sales area. The display type cannot be changed. In this instruction manual, screens of the 24-hour display type are used as examples.

Notes on playing MP3/WMA/JPEG/MPEG

This unit can play MP3 (MPEG1 Audio Layer 3)/WMA/JPEG/MPEG (MPEG 1/2). Note, however, that the MP3/WMA/JPEG/MPEG recording media and formats acceptable are limited. When writing MP3/WMA/JPEG/MPEG, pay attention to the following restrictions.

Acceptable media

The MP3/WMA/JPEG/MPEG recording media acceptable to this unit are CD-ROM, CD-R, CD-RW, DVD-R/RW and DVD+R/RW.

When using CD-RW, do full format not quick format to prevent malfunction.

Acceptable medium formats

The following formats are available for the media used in this unit. The maximum number of characters used for file name including the delimiter ("") and three-character extension are indicated in parentheses.

- ISO 9660 Level 1 (12 characters)
- ISO 9660 Level 2 (31 characters)
- Joliet (64 characters)
- Romeo (128 characters)

Up to 200 characters can be displayed in the long file name format. For a list of available characters, see the instruction manual of the writing software and the section Entering file and folder names below.

The media reproducible on this unit has the following limitations:

- Maximum number of directory levels: 8
- Maximum number of files per folder: 255
- Maximum number of characters for folder name: 200
- Maximum number of folders: 254

MP3/WMA/JPEG/MPEG written in the formats other than the above may not be successfully played and their file names or folder names are not properly displayed.

Settings for your MP3/WMA/JPEG/MPEG encoder and CD/DVD writer

Do the following setting when compressing audio data in MP3/WMA data with the MP3/WMA encoder.

MP3/WMA

- Transfer bit rate: MP3: 32 —320 kbps
WMA: 48 —192 kbps
- Sampling frequency: MP3: 32, 44.1, 48 kHz
WMA: 32, 44.1, 48 kHz

Do the following setting when compressing video/audio data in JPEG/MPEG data with the JPEG/MPEG encoder.

JPEG

- Picture size: Baseline format: 5,120 (W) x 3,840 (H) pixels
(Maximum size)*1
Progressive format: 2,048 (W) x 1,536 (H) pixels
(Maximum size)*2

MPEG

- Video format: MPEG1, MPEG2
- Picture size: MPEG1: 320x240, 352x240 (NTSC), 352x288 (PAL)
MPEG2: 640x480, 704x480 (NTSC), 704x576 (PAL)
- Audio format: MPEG1 Audio Layer2
- Transfer bit rate: 32—384 kbps CBR
- Sampling frequency: 32, 44.1, 48 kHz

When you use your CD/DVD writer to record MP3/WMA/JPEG/MPEG up to the maximum disc capacity, disable additional writing. For recording on an empty disc up to the maximum capacity at once, check Disc at Once.



- Play mode may not be possible when portions of the functions of Windows Media Player 9 or higher are used.
- *1 A part of picture will not be displayed if the size of a picture exceeds maximum.
- *2 A picture will not be displayed if the size of a picture exceeds maximum.
- When you write for MPEG 2 data, please be sure to use DVD media.
- When you write data in DVD media, please be sure to set a setup of a DVD writer to "Disc at once".

Entering ID3 tag

The Displayable ID3 tag is ID3 version 1.x.
For the character code, refer to the List of Codes.

0	1	2	3	4	5	6	7	8	9	A	B	C	D	E	F
0			@	P	p					▣	▤	A	D	a	d
1			I	I	A	O	a	q		i	±	A	N	ā	ñ
2			"	B	R	b	r	e		▣	A	O	ā	ō	
3			#	3	G	S	s	g		▣	A	O	ā	ō	
4			\$	4	D	T	d	t		▣	A	O	ā	ō	
5			%	5	E	U	e	u		¥	μ	A	O	ā	ō
6			&	6	F	V	f	v		:	¶	Æ	O	æ	ö
7			'	7	G	W	g	w		\$	·	Ç	×	ç	+
8			(8	H	X	h	x		▣	†	E	O	ē	ö
9)	9	I	Y	i	y		⊗	†	E	U	e	ü
A			-	J	Z	j	z			±	±	E	U	e	ü
B			+	K	[k	(±	±	E	U	e	ü
C			<	L	\	l				~	¶	¶	U	ü	ü
D			=	M]	m)			⊗	¶	¶	I	Y	y
E			>	N	^	n	~			⊗	¶	¶	I	P	i
F			/	?	_	o	▣			~	¶	¶	I	B	i

Entering file and folder names

You can use only characters shown on the code table for file name and folder name.

If you use any other character for entry, the file and folder names are not displayed correctly. They may neither be displayed correctly depending on the CD/DVD writer used. The MP3/WMA/JPEG/MPEG file must have the MP3/WMA/JPEG/MPEG extension (.mp3/.wma/.jpg/.mpg).



- A file with a name entered with characters not on the code list may not play correctly.

Writing files into a medium

When a medium containing MP3/WMA/JPEG/MPEG data is loaded, the unit checks all the data on the medium. If the medium contains a lot of folders or non-MP3/WMA/JPEG/MPEG files, therefore, it takes a long time until the unit starts playing MP3/WMA/JPEG/MPEG.

In addition, it may take time for the unit to move to the next MP3/WMA/JPEG/MPEG file or a File Search or Folder Search may not be performed smoothly.



- Loading such a medium may produce loud noise to damage the speakers.
- Do not attempt to play a medium containing a non-MP3/WMA/JPEG/MPEG file with the MP3/WMA/JPEG/MPEG extension. The unit mistakes non-MP3/WMA/JPEG/MPEG files for MP3/WMA/JPEG/MPEG data as long as they have the MP3/WMA/JPEG/MPEG extension.
- Do not attempt to play a medium containing non MP3/WMA/JPEG/MPEG.

MP3/WMA/JPEG/MPEG playing order

When selected for play, Folder Search, File Search, or for Folder Select, files and folders are accessed in the order in which they were written by the CD/DVD writer.

Because of this, the order in which they are expected to be played may not match the order in which they are actually played. You may be able to set the order in which MP3/WMA/JPEG/MPEG are to be played by writing them onto a medium such as a CD-R with their file names beginning with play sequence numbers such as "01" to "99", depending on your CD/DVD writer.

JPEG

JPEG is a standardized image compression mechanism. JPEG stands for Joint Photographic Experts Group, the original name of the committee that wrote the standard. JPEG is designed for compressing either full color or gray scale images.

MPEG 1

The most common implementations of the MPEG 1 standard provide a video resolution of 352-by-240 at 30 frames per second (fps). This produces video quality slightly below the quality of conventional VCR videos.

MPEG 2

MPEG 2 offers resolutions of 720x480 and 1280x720 at 60 fps (NTSC), with full CD-quality audio. This is sufficient for all the major TV standards, including NTSC, and even PAL. MPEG 2 is used by DVD-ROMs. MPEG-2 can compress a 2-hour video into a few gigabytes.

DDX7017/7047 Basic operations

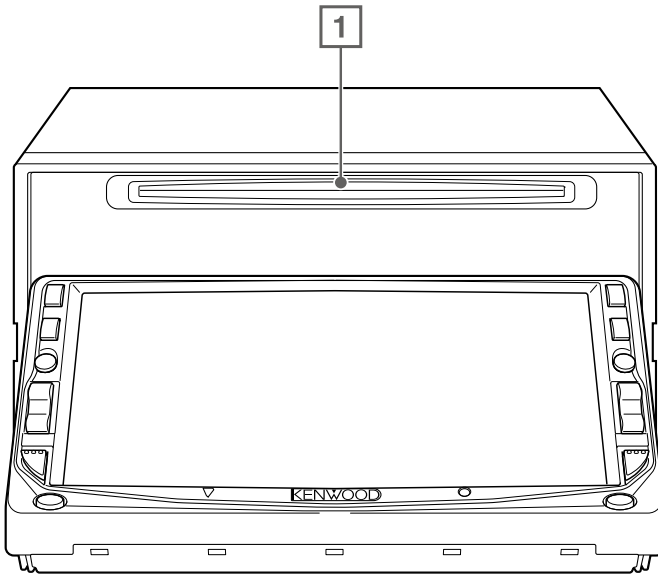
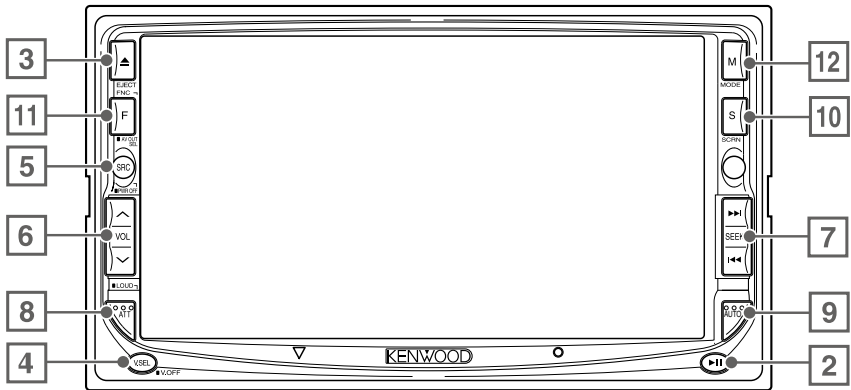

1 Play Disc
[Disc insertion slot]

A disc is played when you insert it.

2 Play/ Pause
[▶||] key

Pauses and replays a disc.

3 Eject Disc
[EJECT] key

The disc is ejected.

4 Video Source Selection/ V.OFF
[V.SEL] key

Video source selection changes in the following order each time you press the key.

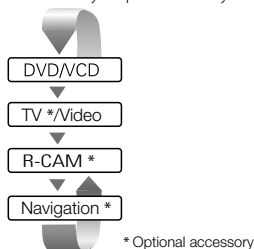

You can also turn off the video display by pressing the key longer than 1 second. When you press the key again, the previous video display comes back on.

5 Audio Source Selection/ Power Supply
[SRC] key

Audio source selection changes in the following order each time you press the key.

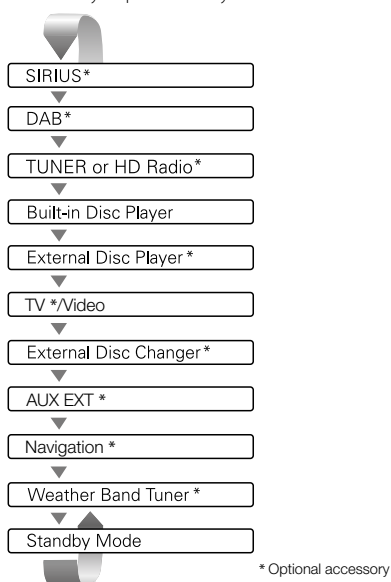

You can also turn off the power by pressing the key longer than 1 second. When you press the key again, the power turns on.

6 Volume Controls
[VOL] key

Adjusts the volume.

7 Track/Station Selectors
[SEEK] key

Selects a music or chapter, track, or frequency.

8 Attenuator/Loudness
[ATT]/[LOUD] key

Attenuates the volume. Press it again to cancel muting. Press it for more than one second to turn the Loudness function on or off. If turned on, high and low tones are enhanced during low volume.

9 Select Seek Mode
[AUTO] key

Selects the Seek mode. (See page 32/38/46/50 for the <Seek Mode>)

10 Screen Setup/ Dimmer
[SCRN] key

Displays the Screen Control or Tilt Control screen. (page 57) The Dimmer Mode Setup is set to "Manual" in the Screen Control screen, the Dimmer function turns On or Off when the key is pressed more than 1 second. (page 57)

11 Function/ AV OUT SEL
[FNC] key

The video source function changes in the following order each time you press the key.

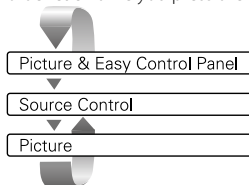

Switches the source that is output at the AV OUTPUT terminal when it is pressed more than 1 second.

12 Switch Screen Mode/ M.CTRL
[MODE] key

Switches the screen mode. (page 14) The DVD Disc Menu screen appears when you hold down the key more than 1 second. (page 20)



• DVD Disc Menu is not available when the top menu of the DVD is shown.



- Aside from the navigation system, the display turns on when you apply the parking brake.
- It is necessary to set "Navigation Source" of <AV Interface> to "On" to add Navigation as an audio source that can be selected with [SRC] key. (page 67)
- It is necessary to engage the shift knob of car to "Reverse" to switch to rear view camera (R-CAM) video display.

Basic Operations of Remote Controller

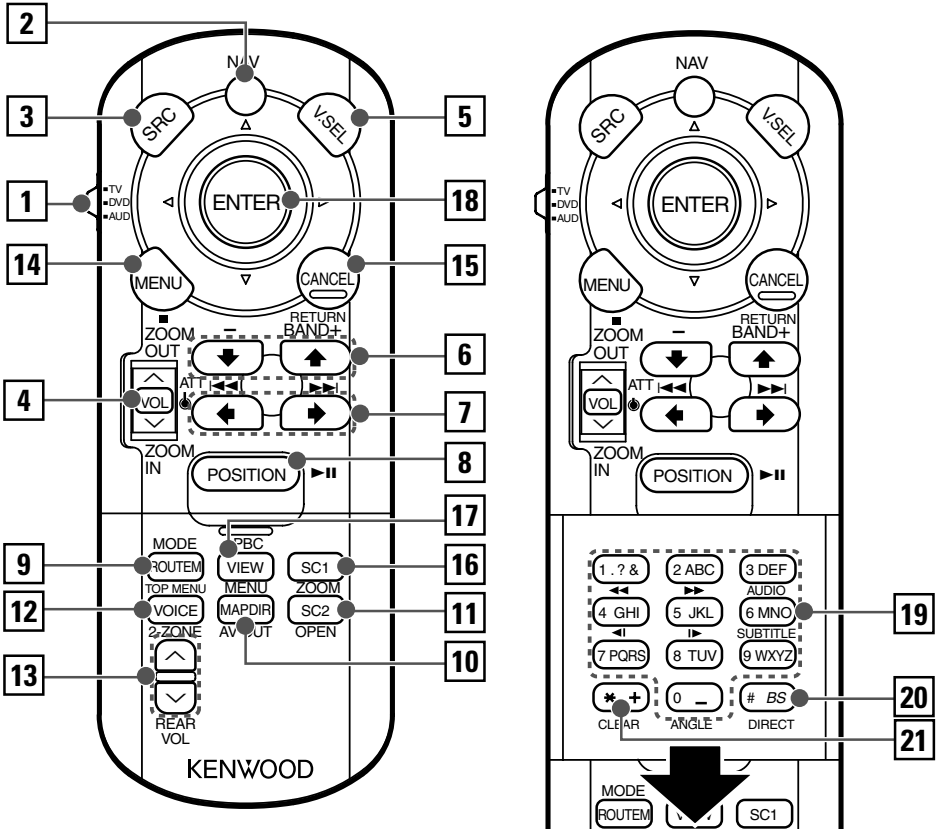

1 Remote Control Mode selector switch

Selects one of the following remote control modes.
 TV: TV source
 DVD: Built-in DVD/VCD/CD/MP3/WMA/JPEG/MPEG player source
 AUD: Tuner source or attached disc changer source

2 [NAV] switch

Pressing the switch until it locks enters into the navigation system control mode. Pressing the switch again returns to the AV control mode.

3 [SRC] key

Audio source changes each time you press the key.

4 [VOL] key

DISC TV TUNER
 Adjusts the volume. When you press the key, the volume attenuates. When you press the key again, the volume returns to the previous level.

NAV
 Zooms in or out the navigation map.

5 [V.SEL] key

Video source selection changes in the following order each time you press the key.

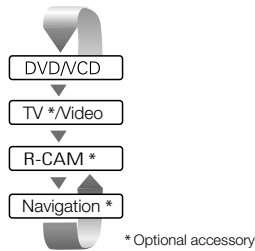

* Optional accessory



- It is necessary to engage the shift knob of car to "Reverse" to switch to rear view camera (R-CAM) video display.

- 6 [BAND] key**
DISC (When **1** is set to "DVD" or "AUD")
 +: Selects next disc.
 -: Selects previous disc.
TV (When **1** is set to "TV" or "AUD")
 BAND: Switches to TV1, TV2, VIDEO1, or VIDEO2.
TUNER (When **1** is set to "AUD")
 +: Switches to the FM1, FM2, or FM3 band.
 -: Switches to the AM band.
NAV
 Selects the icon.
- 7 [◀|▶] key**
DISC (When **1** is set to "DVD" or "AUD")
 Selects a song.
TV (When **1** is set to "TV" or "AUD")
 Selects a channel.
TUNER (When **1** is set to "AUD")
 Selects a station.
NAV
 Selects an icon or scrolls horizontally.
- 8 [▶||] key**
DISC (When **1** is set to "DVD" or "AUD")
 Plays or pauses.
TV (When **1** is set to "TV" or "AUD")
TUNER (When **1** is set to "AUD")
 Selects the Seek mode.
 (page 32/38/46/50 for the <Seek Mode>)
NAV
 Current position.
- 9 [TOP MENU] key**
DVD (When **1** is set to "DVD")
 Calls the Top menu of DVD Disc Menu.
DISC TV TUNER (When **1** is set to "TV" or "AUD")
 Switches the Screen mode. (page 14)
NAV
 Displays Route Option menu.
- 10 [AV OUT] key**
DISC TV TUNER
 Selects an AV source to be output at the AV OUTPUT port.
NAV
 Switches between the heading up navigation and north up navigation map displays.
- 11 [OPEN] key**
DISC TV TUNER
 Each time the key is pressed, the panel slides. Next the full-opened, the panel closes.
NAV
 Jumps to the function registered in Shortcut 2.
- 12 [2-ZONE] key**
DISC TV TUNER
 Turns Zone function on or off each time you press the key.
 (page 80 for the <Zone Control>)
NAV
 Plays Voice guidance.
- 13 [REAR VOL] key**
DISC TV TUNER
 Adjusts the volume of the rear channel. You can adjust the rear channel volume when Zone function is on.
- 14 [MENU] key**
DVD (When **1** is set to "DVD")
 Stops to play the built-in disc play.
NAV
 Displays Main menu.
- 15 [CANCEL] key**
DVD VCD (When **1** is set to "DVD")
 Returns to the previous screen when the DVD/VCD Disc Menu is displayed.
NAV
 Return.
- 16 [ZOOM] key**
DVD VCD (When **1** is set to "DVD")
 Each time you press the button, the zoom ratio switches.
NAV
 Jumps to the function registered in Shortcut 1.
- 17 [MENU] key**
DVD (When **1** is set to "DVD")
 Calls the DVD Disc Menu
VCD (When **1** is set to "DVD")
 Turns the PBC (Playback Control) function On or Off.
NAV
 Switches between 2D and 3D map displays.
- 18 Joystick**
DVD
 Enters your selection from the DVD Disc Menu.
NAV
 Scrolls the map, or moves the cursor.
 Also performs the selected function when you press the button down.

DVD	: An operation during DVD playback
VCD	: An operation during VCD playback
DISC	: An operation during DVD, VCD, CD, MP3/WMA/JPEG/MPEG or MD playback
TV	: An operation during TV source
TUNER	: An operation during FM/AM broadcasting source
NAV	: An operation during Navigation (KNA-DV2100,KNA-DV3100,KNA-DV4100) control mode

19 [0] – [9] key**TV** (When **1** is set to "TV")**TUNER** (When **1** is set to "AUD")**MEMO** : Recall the stations on memory.**NAV**

You can enter a character/number.

[SUBTITLE] key**DVD** (When **1** is set to "DVD")**MEMO** : Switches a subtitle language.**[AUDIO] key****DVD** (When **1** is set to "DVD")**MEMO** : Switches an audio language.**[◀|▶] key****DVD** **VCD** (When **1** is set to "DVD")**◀** : Fast Backward (Rewind). The speed changes each time it is pressed.**▶** : Fast Forward. The speed changes each time it is pressed.**[◀|▶] key****DVD** (When **1** is set to "DVD")**◀** : Slow Backward.**▶** : Slow Forward.**[ANGLE] key****DVD** (When **1** is set to "DVD")**◀** : Switches the view angle**20 [DIRECT] key**

Selects the Direct Search mode.

(page 21/29/34/43 for <Direct Search>)

21 [CLEAR] key**DVD** (When **1** is set to "DVD")

Clears a numeric value you have entered in the built-in disc player during direct search.

Switching Screen Mode

The Screen mode of the monitor changes each time the [MODE] key is pressed.

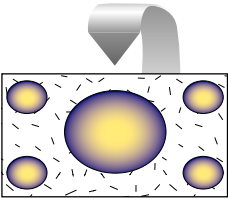
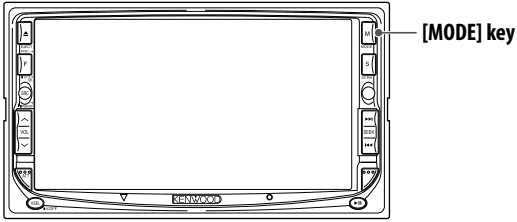

Full picture mode (FULL)

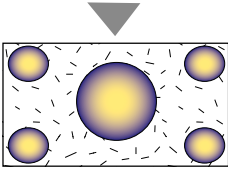

Justify picture mode (JUST)

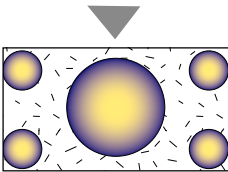

Cinema picture mode (CINEMA)

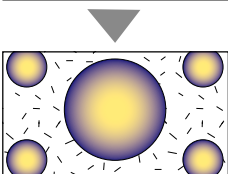

Zoom picture mode (ZOOM)

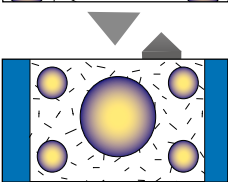

Normal picture mode (NORMAL)



- When you select the Menu, Easy Control screen, or Navigation, the display is shown in the full-size display mode automatically. The screen mode of these displays cannot be changed.
- You can set the screen mode for each of the DVD/VCD, TV and video images.

Muting Audio Volume upon Reception of Phone call

Muting Audio Volume upon Reception of Phone call

When the telephone is called, the system is paused automatically.

When the telephone is called...

The Phone Call ("CALL") screen appears, and system is paused.

Phone Call ("CALL") screen

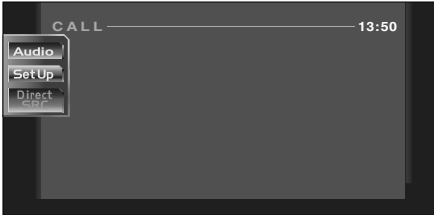

If you want to continue to listen to the audio source during phone call...



The system resumes audio play during the phone call.

When the call ends...

Hang up the phone.

The system resumes playing automatically.

Controlling during DVD Video, Video CD, JPEG or MPEG Playback

Various control screens appear when you play back a DVD Video (DVD), a Video CD (VCD) disc, a JPEG or a MPEG files.

Displaying the DVD/VCD/JPEG/MPEG Playback screen

You can use the following operations when displaying DVD/VCD/JPEG/MPEG images.



DVD playback screen

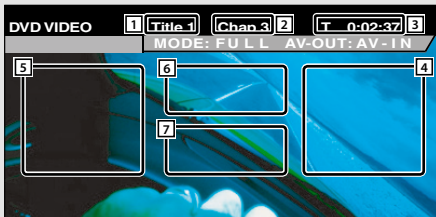

VCD playback screen

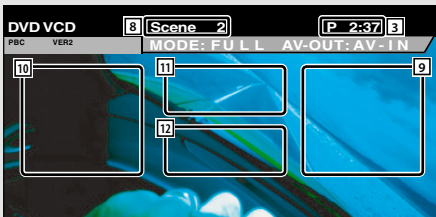

- 1 Title Number Display
- 2 Chapter Number Display
- 3 Play Time Display
- 4 Forward Chapter Search Area
Selects the next chapter.
- 5 Backward Chapter Search Area
Selects the previous chapter.
- 6 DVD Disc Menu Control Buttons Area
Displays the Disc Menu Control buttons (page 20).



- When you touched during DVD menu played it will change to Highlight screen. (page 20).

- 7 Information Display Button Area (page 21)

- 8 Scene/Track Number Display
- 9 Forward Scene/Track Search Area
Selects the next scene (when PBC is On) or track (when PBC is Off).
- 10 Backward Scene/Track Search Area
Selects the previous scene (when PBC is On) or track (when PBC is Off).
- 11 Zoom Control Button Area
Displays the Zoom Control buttons (page 21).
- 12 Information Display Button Area (page 21)



- For DVD/VCD playback, DVD/VCD picture selection, or controller key operations, see <DDX7017/7047 Basic Operations> (page 8).
- The information display is cleared automatically after approximately 5 seconds. Also, the information can be displayed automatically when it is updated (page 68).

JPEG/MPEG playback screen

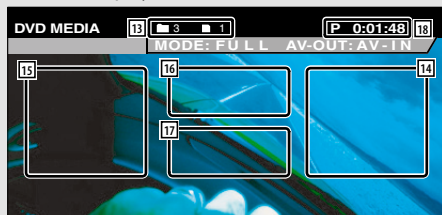

- 13 Folder/File Number Display
- 14 Forward File Search Area
Selects the next folder or file.
- 15 Backward File Search Area
Selects the previous folder or file.
- 16 Picture Control Button Area (page 21)
JPEG playback only.
- 17 Information Display Button Area (page 21)
- 18 Play Time Display



- The Easy control panel functions are seeing page 22.

Displaying the Easy Control Panel

The Control Panel is displayed in a floating position of the DVD/VCD screen.



Displaying the Easy Control Panel

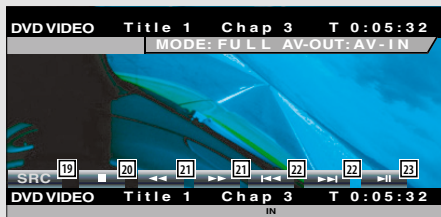

- 19 Switches the source.
- 20 Stops to play.
When pressed twice, the disc is played from its beginning when you play it in the next time.
- 21 Fast Forwards or Fast Backwards.
- 22 Chapter Search **DVD**
Searches for a chapter.
- Scene/Track Search **VCD**
Selects a scene (when PBC is On) or a track (when PBC is Off).
- 23 Plays or pauses.



- The Easy Control Panel is hidden when you touch a central part of the monitor.

Displaying the DVD/VCD Control screen

Plays a DVD/VCD using various functions.



DVD/VCD Control screen



- 24 Ejects the disc from the built-in disc player.
- 25 Calls the Sound Effects Menu. (page 76)
- 26 Calls the Setup Menu. (page 58)
- 27 Displays the Source Select screen. (page 56)
- 28 Fast Forwards or Fast Backwards.
- 29 Stops to play.
When pressed twice, the disc is played from its beginning when you play it in the next time.
- 30 Selects a chapter, a scene or a track.
When the DVD/VCD is paused, touch this button to start single-frame stepping.
- 31 Plays or pauses.
- 32 Slow Forwards or Backwards. **DVD**
- 33 Turns the PBC function of VCD On or Off. (only when VCD Ver 2.0 is in use)
- 34 Switches the Repeat Play operations in the following sequence.
DVD: Title Repeat, Chapter Repeat, Repeat Off
VCD: Track Repeat, Repeat Off (Available when the PBC is off)
- 35 Scrolls the display text.
- 36 Switches the play time display in the following sequence.
DVD: Title, chapter, remaining titles
VCD: Track, disc, remaining discs (Effective only when the PBC function is off)
- 37 **Title Number Display** **DVD**
- 38 **Chapter/Scene/Track Number Display**
- 39 **Play Time Display**
- 40 Appears when a disc is inserted.
- 41 **Function Indicator**
- 42 **Volume Label Display**

DVD Disc Menu

Selects an option from the DVD Disc Menu.

1 Display the Disc Menu Control screen



6 DVD Disc Menu Control Buttons Area (page 16)

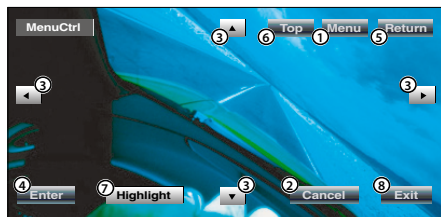

- 1 Calls the Menu.
- 2 Returns to the Disc Menu Control screen.
- 3 Selects a menu option.
- 4 Enters your menu selection.
- 5 Returns to the previous menu screen.
- 6 Displays the Top Menu.
- 7 Highlight Control.
- 8 Clears the Disc Menu Control.

Highlight Control

You can select a chapter and title for the DVD Menu screen. When you touch a chapter and title, it is played back.



Highlight

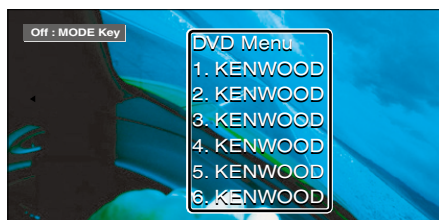

- To cancel Highlight Control, press "MODE" key. (page 9)

2 Select Disc Menu options

Disc Menu



Cancel

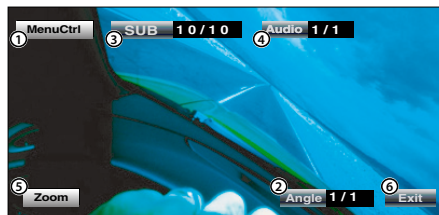

- 1 Calls the Menu Control.
- 2 Switches the picture angle. (during program playback only)
- 3 Switches the subtitle language. (during program playback only)
- 4 Switches the voice language. (during program playback only)
- 5 Displays the Zoom Control screen.
- 6 Clears the Disc Menu Control.

Zoom Control



Zoom



- 1 Changes the zoom ratio at 4 levels (2 times, 3 times, 4 times, or off) each time you touch.
- 2 Scrolls the screen in the direction you touch.
- 3 Returns to the Disc Menu Control screen.
- 4 Clears the Disc Menu Control.

VCD Zoom Control

Displays an enlarged VCD screen.

1 Display the Zoom Control screen



11 Zoom Control Button Area (page 16)

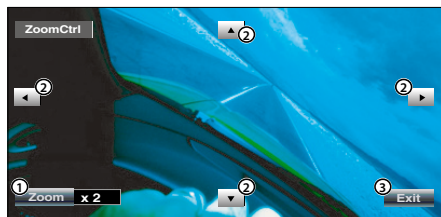

- ① Changes the zoom ratio at 4 levels (2 times, 3 times, 4 times, or off) each time you touch.
- ② Scrolls the screen in the direction you touch.
- ③ Clears the Zoom Control button.

Picture Control

Rotates picture for JPEG files.

1 Display the JPEG Menu Control screen



16 JPEG Menu Control Button Area (page 17)

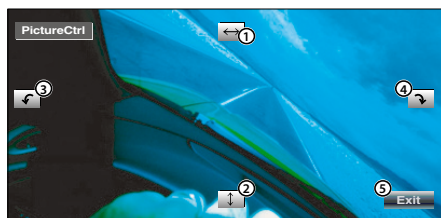

- ① Switches the picture flip horizontal.
- ② Switches the picture flip vertical.
- ③ Rotates the picture counter clockwise.
- ④ Rotates the picture clockwise.
- ⑤ Hides the Picture Control button.

Information Display

Displays the DVD and AV information.



7 **12** **17**

Information Display Button Area (page 16,17)

The information is displayed for 5 seconds.

Direct Search

You can search for a DVD/VCD chapter, scene or track by entering its number.

1 Select the Direct Search mode



BS
DIRECT

The following items can be searched directly each time it is pressed.

DVD: Title, Chapter, Time, Direct number
VCD (when PBC is On): Scene, Direct number
VCD (when PBC is Off): Track, Time

However, the direct search may not be supported for some discs.

2 Enter a number or time



0 - 9 WXYZ

When playing back a VCD, enter a PBC screen number (if PBC is On) or a track number (if PBC is Off).



- To clear your incorrect entry, press **CLEAR** (CLEAR).

3 Search



POSITION ►►



- The operation ends automatically if you do not operate within 10 seconds.

CD/MP3/WMA/JPEG/MPEG/Disc Changer Play Control

You can recall various control screens during CD/MP3/WMA/JPEG/MPEG/Disc Changer playback.

Displaying the Easy Control Panel

The CD/MP3/WMA/JPEG/MPEG/Disc Changer Play Control Panel is displayed in a floating position of the selected picture.



Displaying the Easy Control Panel During CD playback

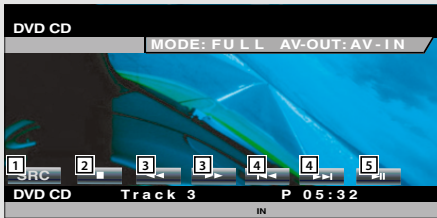

During MP3/WMA/JPEG/MPEG playback



During playback on disc changer



During playback on CD player



- 1 Switches the source.
- 2 Stops to play the built-in disc player.
- 3 Fast Forwards or Fast Backwards. (only when a CD is played back on the built-in disc player).
- 4 Selects a track or data.
When you continue to touch button:
Fast Forwards or Fast Reverse.
(Disabled when a JPEG is being played.)
- 5 Plays or pauses.
- 6 Selects an MP3/WMA/JPEG/MPEG file. (only when an MP3/WMA/JPEG/MPEG is played back on the built-in disc player)
- 7 Selects a disc. (only when a disc is played back on the disc changer)



- For CD/MP3/WMA/JPEG/MPEG/Disc Changer playback and receiver key operations, see <DDX7017/7047 Basic Operations> (page 8).
- The Easy Control Panel is hidden when you touch a central part of the monitor.

Displaying the CD/MP3/WMA/JPEG/MPEG/Disc Changer Control screen

You can play the CD/MP3/WMA/JPEG/MPEG/Disc changer using various functions.



CD Control screen

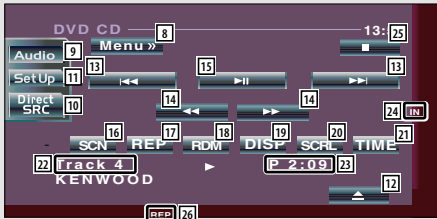

During CD playback

- 8 Calls the CD/MP3/WMA/JPEG/MPEG/Disc Changer Menu.
- 9 Calls the Sound Effects Menu. (page 76)
- 10 Displays the Source Select screen. (page 56)
- 11 Calls the Setup Menu. (page 58)
- 12 Ejects the disc from the built-in disc player.
- 13 Selects a track.
- 14 Fast Forwards or Fast Backwards.
- 15 Plays or pauses.
- 16 Starts or stops Scan Play (that plays the beginning of each song one after the other).
- 17 Repeats to play (the present track).
- 18 Starts or stops Random Play (to play songs in random order).
- 19 Selects the Disc Name (see <Set Disc Name>, page 27), Disc Text, or Track Text mode for text display.
- 20 Scrolls the display text.
- 21 Switches the play time display between Track, Disc, and Disc Remaining Time.
- 22 **Track Number Display**
- 23 **Play Time Display**
- 24 Appears when a disc is inserted.
- 25 Stops to play the built-in disc player.
When pressed twice, the disc is played from its beginning when you play it in the next time.
- 26 **Function Indicator**

MP3/WMA/JPEG/MPEG Control screen



During MP3/WMA/JPEG/MPEG play

- 27 Ejects a disc.
- 28 Fast Forwards or Fast Backwards.
(Disabled when a JPEG is being played.)
- 29 Stops to play.
When pressed twice, the disc is played back from its beginning in the next time.
- 30 Selects a song.
- 31 Plays or pauses.
- 32 Selects a folder.
- 33 Starts or stops Scan Play (that plays the beginning of each song or data one after the other).
- 34 Repeats to play (the preset song or data).
- 35 Starts or stops Random Play (to play songs of the present folder in random order).
- 36 Selects the Folder name, File name, Title (ID3/WMA tag), Artist name (ID3/WMA tag), or Album name (ID3 tag) for text display.
- 37 Scrolls the display text.
- 38 Switches the button display.
- 39 Repeats to play the song or data of the present folder.
- 40 **Folder and File Number Display**
- 41 **Play Time Display**
- 42 Appears when a disc is inserted.
- 43 **Function Indicator**

Disc changer/CD player Control screen

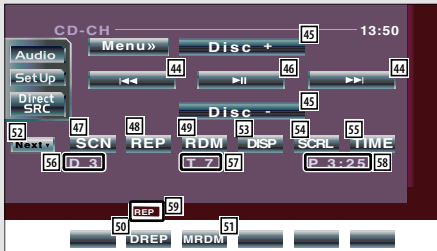

During play by the disc changer/CD player

- 44 Selects a track.
Starts Fast Forward or Fast Backward when it is held down.
- 45 Selects a disc. (Function of Disc Changer)
- 46 Plays or pauses.
- 47 Starts or stops Scan Play (that plays the beginning of each song one after the other).
- 48 Repeats to play (the present current track).
- 49 Starts or stops Random Play (to play songs in random order).
- 50 Repeats to play a disc (the present current disc). (Function of Disc Changer)
- 51 Starts or stops Magazine Random Play (to play songs of the disc changer in random order). (Function of Disc Changer)
- 52 Switches the button display.
- 53 Selects the Disc Name (see <Set Disc Name>, page 27), Disc Text, or Track Text mode for text display.
- 54 Scrolls the display text.
- 55 Switches the play time display between Track, Disc, and Disc Remaining Time.
- 56 **Disc Number Display** (Function of Disc Changer)
- 57 **Track Number Display**
- 58 **Play Time Display**
- 59 **Function Indicator**



- The functions that can be used and the information that can be displayed will differ depending on the models being connected.
- The information shown will be different depending on the Disc Changer being used.

Displaying the CD/MP3/WMA/JPEG/MPEG/Disc Changer Menu screen

You can select menu options using various functions.



Menu»

CD Menu screen



60 Selects option from various function menus.

61 Returns to the CD/MP3/WMA/JPEG/MPEG/Disc Changer Control screen.



- The available functions vary depending on the source used.

ID3/WMA TAG Display (during MP3/WMA play)

The ID3/WMA TAG information of MP3/WMA file is listed.

1 Call the MP3/WMA/JPEG/MPEG Menu



2 Display the ID3/WMA TAG



- ① Scrolls the list.

Disc Select (during play by disc changer)

The discs loaded on the disc changer are listed for quick disc selection.

1 Call the Disc Changer Menu



2 Call the Disc Select Menu



- ① Plays the displayed disc.
② Selects the Disc Name or Disc Text mode for text display.
③ Scrolls the list.
(It is not displayed when a disc changer having 6 or less discs is used.)

3 Select the desired disc



Touch the desired disc display.

Direct Search

Searches for a disc or a track when its number is entered.

During play on the built-in disc player

1 Select the Direct Search mode



The following items can be searched directly each time it is pressed.

CD: Track number, Total play time

MP3/WMA/JPEG/MPEG: Folder, File

2 Enter a track number



3 Search

When searching for a track:



During play on an external in disc player or disc changer

1 Enter a disc or track number



2 Search

When searching for a track:



When searching for a disc:



- The operation ends automatically if you do not operate within 10 seconds.

Tuner Control

Various control screens appear in the Tuner Source mode.

Displaying the Easy Control Panel

The Tuner Control Panel is displayed in a floating position of the selected picture.



Displaying the Easy Control Panel

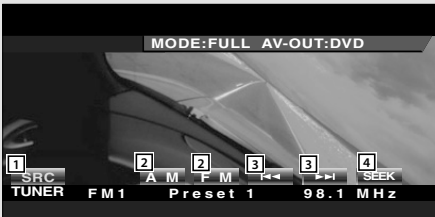

- 1 Switches the source.
- 2 Switches the band (to AM or FM1/2/3).
- 3 Tunes in a station
- 4 Switches the Seek mode.
(See page 32 for the <Seek Mode>)



- For receiver key operations, see <DX7017/7047 Basic Operations> (page 8).
- The Easy Control Panel is hidden when you touch a central part of the monitor.

Displaying the Tuner Control screen

You can tune in a station using various functions.



Tuner Control screen

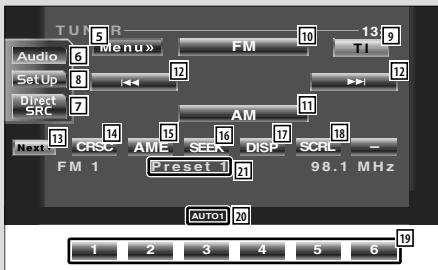

- 5 Calls the Tuner Menu.
- 6 Calls the Sound Effects Menu. (page 76)
- 7 Displays the Source Select screen. (page 56)
- 8 Calls the Setup Menu. (page 58)
- 9 Turns the Traffic Information function On or Off. (see <Traffic Information>, page 34)
- 10 Switches to the FM1/2/3 band.
- 11 Switches to the AM band.
- 12 Tunes in a station.
Use the <Seek Mode> (page 32) to change the frequency switching.
- 13 Switches between **1** to **6** buttons and Function buttons to use.
- 14 Turns the CRSC function On or Off. (Only when receiving the FM broadcast)
- 15 Selects the Auto Memory mode.
(See page 32 for the <Auto Memory>)
- 16 Switches the Seek mode.
(See page 32 for the <Seek Mode>)
- 17 Selects the Program Service Name, Station Name, or Radio Text mode for text display.
- 18 Scrolls the display text.



Displaying the Tuner Menu screen

You can select menu options using various functions.



Menu»

Tuner Menu screen

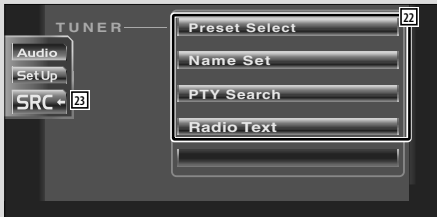

19 When **1** to **6** buttons appear, you can recall the stations on memory.

For memory of broadcasting stations, see <Auto Memory> (page 32) or <Manual Memory> (page 32).

20 Indicates current Seek mode

21 Memory Number Display

22 Selects option from various function menus.

23 Returns to the Tuner Control screen.



- The available functions vary depending on the model used (the tuner specifications and the broadcasting system that can be received).

Seek Mode

Sets a station selection.



If **SEEK** is not shown, touch **Next**.

The mode is switched in following order each time you touch the button.

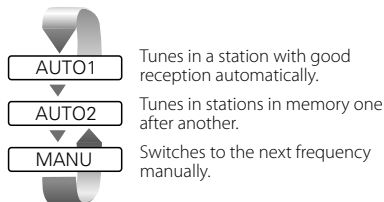

Auto Memory

Stores stations with good reception in memory automatically.

1 Select a band you wish to store in memory



2 Select the Auto Memory mode



If **AME** is not shown, touch **Next**.

3 Start Auto Memory



Touch  or .

Auto Memory terminates when 6 stations are stored or when all stations are tuned in.



- The operation ends automatically if you do not operate within 10 seconds.

Manual Memory

Stores the current receiving station in memory.

1 Select a station you wish to store in memory



2 Store in memory



If **1** to **6** are not shown, touch **Next**. Continue to touch until the memory number appears.

Preset Select

Lists and tunes in stations in memory one after the other.

1 Call the Tuner Menu



Menu»

2 Call the Preset Select Menu



Preset Select



- ① Tunes in the displayed station.
The station name is displayed if previously set.
- ② Switches the band of the displayed station list.
- ③ Calls the band and frequency.
- ④ Returns to the Tuner Menu.
- ⑤ Switches the Station List display between the Program Service Name and SNPS (Frequency).

Set Station Name

Names a station.

1 Tune in a station you wish to name



2 Call the Tuner Menu



Menu»

3 Select the Set Name mode



Name Set

4 Enter a name

For character entry details, see <Character Entry> (page 55).

5 Exit the Set Name mode



Ok



- You can store up to 30 stations in memory.
- You can set a station name only after you have applied the parking brake.

Direct Search

Tunes in a station when its frequency is entered.

1 Select a band

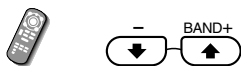

2 Select the Direct Search mode



3 Enter frequency



When you enter frequency, signal reception starts.

Example: When you receive FM 92.1 MHz

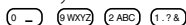

Example: When you receive AM 810 kHz



- The operation ends automatically if you do not operate within 10 seconds.

Traffic Information

When a traffic bulletin starts, any source is switched to the traffic information and it is displayed automatically.

When the traffic bulletin starts...

The Traffic Information screen appears automatically.

Traffic Information screen

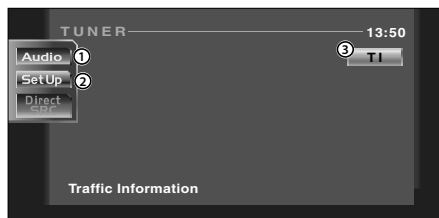

- ① Calls the Sound Effects Menu. (page 76)
- ② Calls the Setup Menu. (page 58)
- ③ Turns the Traffic Information function on or off.

If you continue to listen to the audio source during traffic bulletin...



- It is necessary to have Traffic Information function set to On in order to have the Traffic Information screen appear automatically.
- During reception of traffic information the adjusted volume is automatically remembered, and the next time it switches to traffic information it's automatically the remembered volume.

Search for Program Type

A program is tuned when you set its program type.
(Only when receiving the FM broadcast)

1 Call the Tuner Menu



2 Call the PTY Search Menu



- ① Selects a program type.
- ② Scrolls the program type list.
- ③ Searches for the program type.
It is displayed when the Program Type is selected.
- ④ Continue to touch more than 2 seconds, the currently receiving station is registered to have the selected program type.
- ⑤ Returns to the Tuner Menu.

3 Select a program type



4 Search for the program type



Radio Text

You can display the radio text. (Only when receiving the FM broadcast)

1 Call the Tuner Menu



2 Display the Radio Text

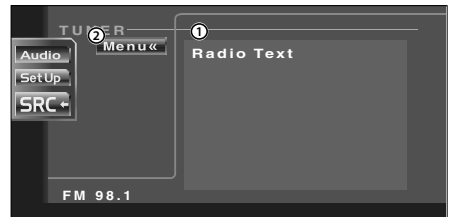

- ① Displays the Radio Text.
- ② Returns to the Tuner Menu.

TV/ Video Control

Various control screens appear in the TV/ Video Source mode. (You can only operate TV with the optional accessory TV Tuner connected.)

Displaying the TV Picture screen

Various control screens appear in the TV Source mode.



Select the TV Pictures.

TV Picture screen

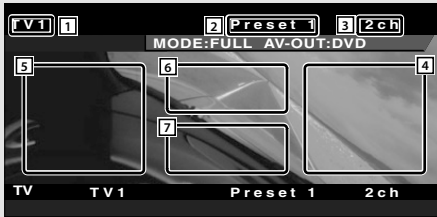

- 1 TV Band Number Display
- 2 Memory Number Display
- 3 Channel Number Display
- 4 Channel Up Area
Increase the channel.
- 5 Channel Down Area
Decrease the channel.
- 6 Band/Video Switch Area
Switches to TV1, TV2, or VIDEO.
- 7 Information Display Button Area



- For TV picture selection and receiver key operations, see <DDX7017/7047 Basic Operations> (page 8).
- The information display is cleared automatically after approximately 5 seconds. Also, the information can be displayed automatically when it is updated (page 68).

Displaying the Easy Control Panel

The Control Panel is displayed in a floating position of the TV picture.



Displaying the Easy Control Panel

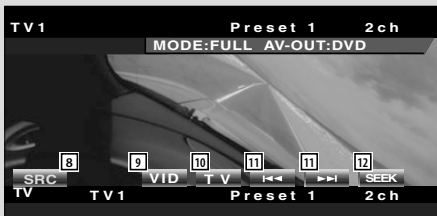

- 8 Switches the source.
- 9 Switches to Video (VIDEO).
- 10 Switches the TV band (to TV1 or TV2).
- 11 Select a channel.
Use the <Seek Mode> (page 38) to change the channel tuning sequence.
- 12 Switches the Seek mode.
(page 38 for the <Seek Mode>)



- The Easy Control Panel display is hidden when you touch a central area of the monitor.

Displaying the TV Control screen

You can tune in a TV station using various functions.



TV Control screen

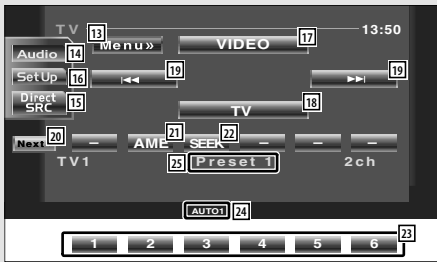

- 13 Calls the TV Menu.
- 14 Calls the Sound Effects Menu. (page 76)
- 15 Displays the Source Select screen. (page 56)
- 16 Calls the Setup Menu. (page 58)
- 17 Switches to VIDEO.
- 18 Switches to TV1 or TV2.
- 19 Select a channel.
Use the <Seek Mode> (page 38) to change the channel tuning sequence.
- 20 Switches between **1** to **6** buttons and Function buttons to use.
- 21 Selects the Auto Memory mode. (page 38 for the <Auto Memory>)
- 22 Switches the Seek mode. (page 38 for the <Seek Mode>)
- 23 When **1** to **6** buttons appear, you can recall channels on memory.
For memory of broadcasting stations, see <Auto Memory> (page 38) or <Manual Memory> (page 38).
- 24 Indicates current Seek mode.
- 25 Memory Number Display

Displaying the TV Menu screen

You can select menu options using various functions.



TV Menu screen

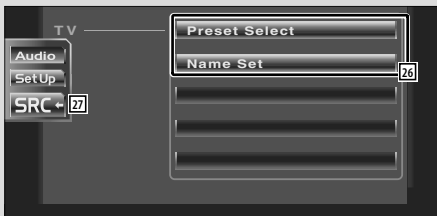

- 26 Selects option from various function menus.
- 27 Returns to the TV Control screen.

Seek Mode

Sets a station selection.



If **SEEK** is not shown, touch **Next**.

The mode is switched in following order each time you touch the button.

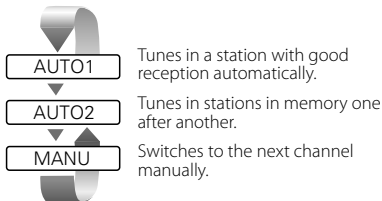

Auto Memory

Stores stations with good reception in memory automatically.

1 Select a band you wish to store in memory



2 Select the Auto Memory mode



If **AME** is not shown, touch **Next**.

3 Start Auto Memory



Touch or .

Auto Memory terminates when 6 stations are stored or when all stations are tuned in.



- The operation ends automatically if you do not operate within 10 seconds.

Manual Memory

Stores the current receiving channel in memory.

1 Select a channel you wish to store in memory



2 Store in memory



If **1** to **6** are not shown, touch **Next**. Continue to touch until the memory number appears.

Preset Select

Lists and tunes in stations in memory one after the other.

1 Select a band you wish to call



2 Call the TV Menu



3 Call the Preset Select Menu

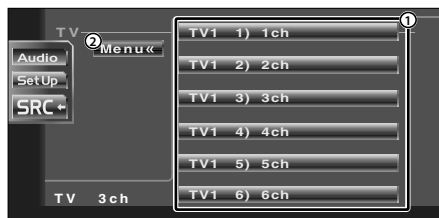

- Tunes in the displayed station. The station name is displayed if previously set.
- Returns to the TV Menu.

Set Station Name

Names a station.

1 Select a station you wish to name



2 Call the TV Menu



3 Select the Set Name mode



4 Enter a name

For character entry details, see <Character Entry> (page 55).

5 Exit the Set Name mode



- You can store up to 20 stations in memory.
- You can set a station name only after you have applied the parking brake.

Direct Search

Tunes in a station when its channel number is entered.

1 Select the Direct Search mode



2 Enter a channel number



When you enter a channel number, signal reception starts.

Example: When you receive Channel 06



- Direct Search ends automatically if you do not operate within 10 seconds.

SIRIUS Tuner Control <North American sales only>

Various control screens appear in the SIRIUS Tuner source mode. (with the optional accessory SIRIUS Tuner connected only)

Displaying the Easy Control Panel

The SIRIUS Tuner Control Panel is displayed in a floating position of the selected picture.



Displaying the Easy Control Panel

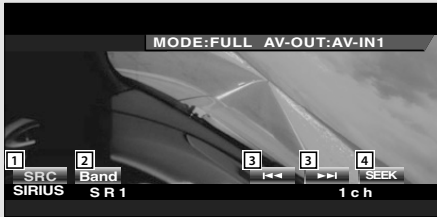

- 1 Switches the source.
- 2 Switches the band.
- 3 Tunes in a station.
- 4 Switches the Seek mode.
SEEK 1: Tunes channels one after the other.
SEEK 2: Selects channels in memory one after the other.



- For system key operations, see <DDX7017/7047 Basic Operations> (page 8).
- The Easy Control Panel display is hidden when you touch a central area of the monitor.

Displaying the SIRIUS Tuner Control screen



SIRIUS Tuner Control screen

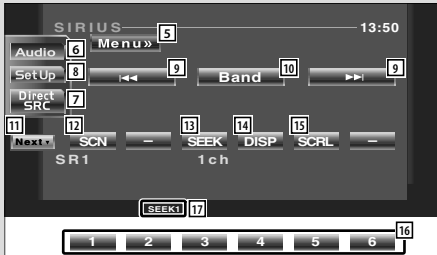

- 5 Calls the SIRIUS Tuner Menu.
- 6 Calls the Sound Effects Menu. (page 76)
- 7 Displays the Source Select screen. (page 56)
- 8 Calls the Setup Menu. (page 58)
- 9 Tunes in a station.
- 10 Switches the band.
- 11 Switches between **1** to **6** buttons and Function button to use.
- 12 Starts or stops Channel Scan (that tunes channels one after the other).
- 13 Switches the Seek mode.
SEEK 1: Tunes channels one after the other.
SEEK 2: Selects channels in memory one after the other.
- 14 Changes the display from Song Title & Artist Name, Composer Name, Channel Name, to Category Name.
- 15 Scrolls the display text.



Displaying the SIRIUS Tuner Menu

You can select menu options using various functions.



Menu >

SIRIUS Tuner Menu screen

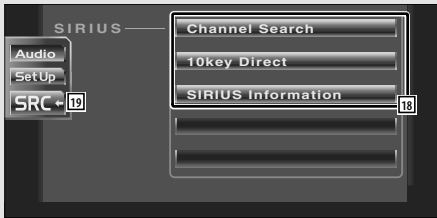

16 When **1** to **6** buttons appear, you can recall the channel on memory.
For memory of channel stations, see <Channel Memory> (page 42) .

17 Indicates current Seek mode

18 Selects option from various function menus.

19 Returns to the SIRIUS Tuner Control screen.



- For SIRIUS Tuner function details, see the Instruction Manual of SIRIUS Satellite Radio Tuner (optional accessory).

Channel Search

The categories and channels are listed for your channel selection.

1 Call the SIRIUS Tuner Menu



Menu»

2 Start Channel Searching



Channel Search

The category list appears.

Category Selection screen



- ① Selects a category.
- ② Scrolls the list.
- ③ Returns to the SIRIUS Tuner Menu.

3 Select a category



CAT. Pop

etc.

The channel list of the selected category appears.

Channel Selection screen

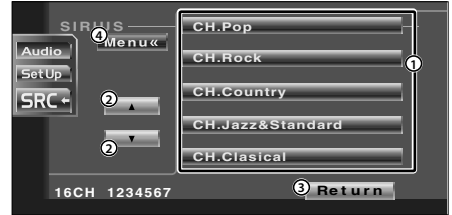

- ① Tunes in a channel.
- ② Scrolls the list.
- ③ Returns to the Category Selection screen.
- ④ Returns to the SIRIUS Tuner Menu.

4 Select a channel



CH. Pop

etc.

The selected channel is tuned.

Channel Memory

Stores the current receiving channel in memory.

1 Select a channel you wish to store in memory



Band



2 Store in memory



2sec

1

2sec

6

If 1 to 6 are not shown, touch **Next**. Continue to touch until the memory number appears.

Direct Channel Search

A channel is tuned when you enter its number.

1 Call the SIRIUS Tuner Menu



Menu»

2 Display the Direct Search screen



10key Direct

Direct Search screen



- ① Enters a channel number.
- ② Returns to the SIRIUS Tuner Menu.
- ③ Tunes in a channel when you enter its number.

3 Enter a channel number



0 — 9

4 Tuning



Enter

Information Display

The tuned program information is displayed.

1 Call the SIRIUS Tuner Menu



Menu»

2 Display the Information screen



SIRIUS Information

Information screen



- ① Displays the information (such as Channel Name, Category Name, Artist Name, Song Title, and Composer).
- ② Scrolls the information display.
- ③ Returns to the SIRIUS Tuner Menu.

HD Radio Control <North American sales only>

Various control screens appear in the HD Radio Source mode. (with the optional accessory HD Radio tuner connected only)

Displaying the Easy Control Panel

The HD Radio Control Panel is displayed in a floating position of the selected picture.



Displaying the Easy Control Panel

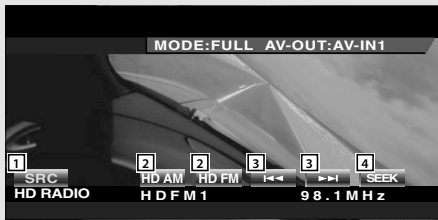

- 1 Switches the source.
- 2 Switches the band (HD FM1/2/3, HD AM).
- 3 Tunes in a station.
- 4 Switches the Seek mode.
(See page 46 for the <Seek Mode>)



- For receiver key operations, see <DDX7017/7047 Basic Operations> (page 8).
- The Easy Control Panel display is hidden when you touch a central area of the monitor.

Displaying the HD Radio Control screen

You can tune in a station using various functions.



HD Radio Control screen

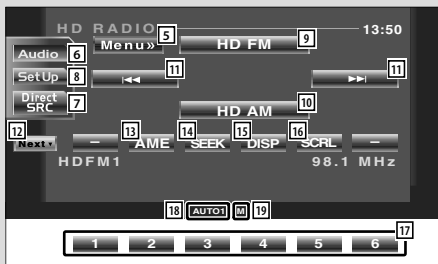

- 5 Calls the HD Radio Menu.
- 6 Calls the Sound Effects Menu. (page 76)
- 7 Displays the Source Select screen. (page 56)
- 8 Calls the Setup Menu. (page 58)
- 9 Switches to the HD FM1/2/3 band.
- 10 Switches to the HD AM band.
- 11 Tunes in a station.
Use the <Seek Mode> (page 46) to change the frequency switching.
- 12 Switches between **1** to **6** buttons and Function buttons to use.
- 13 Selects the Auto Memory mode.
(See page 46 for the <Auto Memory>)
- 14 Switches the Seek mode.
(See page 46 for the <Seek Mode>)
- 15 Switches between Station Name and Song Title display modes.
- 16 Scrolls the display text.



- [SCRL] button is not displayed when there is no text information.

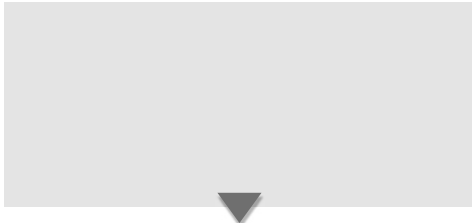

- 17 When **1** to **6** buttons appear, you can recall the stations on memory. For memory of broadcasting stations, see <Auto Memory> (page 46) or <Manual Memory> (page 46).
- 18 Indicates current Seek mode
- 19 M/S Indicator

Displaying the HD Radio Menu screen

You can select menu options using various functions.



Menu >

HD Radio Menu screen



- 20 Selects option from various function menus.
- 21 Returns to the HD Radio Control screen.



- For HD Radio function details, see the Instruction Manual of HD Radio tuner (optional accessory).

Seek Mode

Sets a station selection.



If **SEEK** is not shown, touch **Next**.

The mode is switched in following order each time you touch the button.

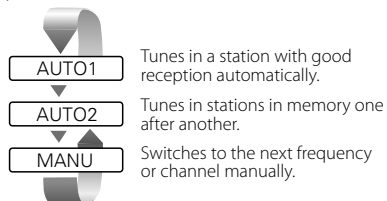

Auto Memory

Stores stations with good reception in memory automatically.

1 Select a band you wish to store in memory



2 Select the Auto Memory mode



If **AME** is not shown, touch **Next**.

3 Start Auto Memory



Touch  or .

Auto Memory terminates when 6 stations are stored or when all stations are tuned in.

Manual Memory

Stores the current receiving station in memory.

1 Select a station you wish to store in memory



2 Store in memory



If **1** to **6** are not shown, touch **Next**. Continue to touch until the memory number appears.

Receive Mode

The digital or analog program is selected and received.

1 Call the HD Radio Menu



2 Call the Receive mode Menu

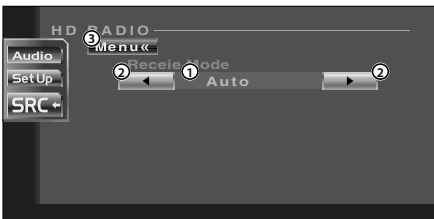

- ① Receive mode Display.
- ② Switches the Receive mode.
- ③ Returns to the HD Radio Menu.

3 Select the Receive mode



- Auto: Automatically switches between the Digital and Analog Receive modes depending on the broadcasting type. If programs are broadcasted in both modes, the digital program is received. Also, if a program is received in the Ball Game mode (the non-displayed broadcast program), the analog program is automatically received.
- Digital: Receives the digital program only.
- Analog: Receives the analog program only.

Title Display

An information about the received song is displayed.

1 Call the HD Radio Menu



2 Display the Title screen



Title screen



- ① Displays the information.
- ② Scrolls the information display.
- ③ Returns to the HD Radio Menu.

DAB Tuner control

Various control screens appear in the DAB Tuner source mode. (with the optional accessory DAB tuner connected only)

Displaying the Easy Control Panel

The DAB Tuner Control Panel is displayed in a floating position of the selected picture.



Displaying the Easy Control Panel

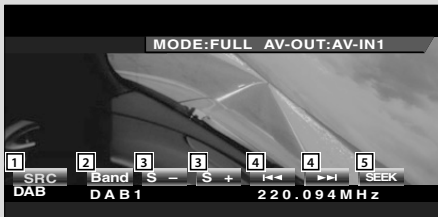

- 1 Switches the source.
- 2 Switches the band (to DAB1/2/3).
- 3 Selects a service.
- 4 Selects the Ensemble.
- 5 Switches the Seek mode.
(See page 50 for the <Seek Mode>)



- For system key operations, see <DDX7017/7047 Basic Operations> (page 8).
- The Easy Control Panel display is hidden when you touch a central area of the monitor.

Displaying the DAB Tuner Control screen

You can select the Ensemble and services using various functions.



DAB Tuner Control screen

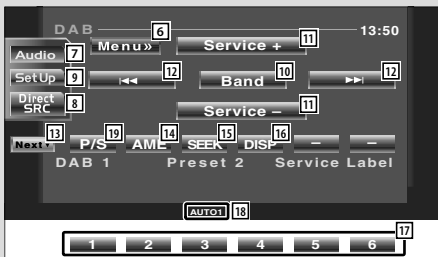

- 6 Calls the DAB Tuner Menu.
- 7 Calls the Sound Effects Menu. (page 76)
- 8 Displays the Source Select screen. (page 56)
- 9 Calls the Setup Menu. (page 58)
- 10 Switches the band (to DAB1/2/3).
- 11 Selects a service.
- 12 Selects the Ensemble.
- 13 Switches between **1** to **6** buttons and Function button to use.
- 14 Selects the Auto memory mode.
(page 50 for the <Auto Ensemble memory>)
- 15 Switches the Seek mode.
(page 50 for the <Seek Mode>)
- 16 Changes the display between Ensemble label, PTY label, Component label, Region label, and Audio quality.
- 17 When **1** to **6** buttons appear, you can recall a service from memory.
- 18 Indicates current Seek mode.
- 19 Selects the primary or secondary operation.

Displaying the DAB Tuner Menu screen

You can select menu options using various functions.



Menu >

DAB Tuner Menu screen

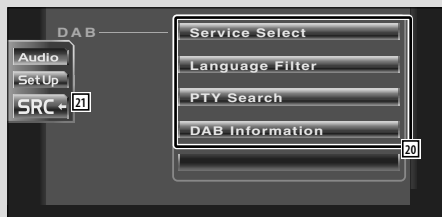

20 Selects option from various function menus.

21 Returns to the DAB Tuner Control screen.



- For DAB Tuner function details, see the Instruction Manual of DAB Tuner (optional accessory).

Seek Mode

Sets a station selection.



If **SEEK** is not shown, touch **Next**.

The mode is switched in following order each time you touch the button.

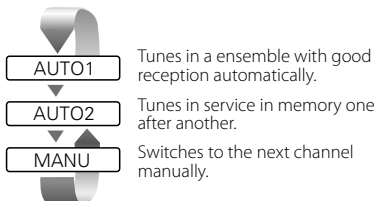

Auto Ensemble Memory

An ensemble with good reception is stored in memory automatically.

1 Select a band you wish to store in memory



2 Select the Auto Memory mode



If **AME** is not shown, touch **Next**.

3 Start Auto Memory



Touch  or .

Auto Memory terminates when 6 stations are stored or when all stations are tuned in.

Service Preset Memory

The current receiving service is stored in memory.

1 Select a service you wish to store in memory



2 Store in memory



If **1** to **6** are not shown, touch **Next**.

Continue to touch until the memory number appears.

Service Select

The service list of the currently receiving ensemble is displayed for your selection.

1 Call the DAB Tuner Menu



Menu»

2 Call the Service Select Menu



Service Select



- ① Selects a service.
- ② Scrolls the service list.
- ③ Returns to the DAB Tuner Menu.

3 Select a service



Service Name

Language Filter

The languages are list for your selection.

1 Call the DAB Tuner Menu



Menu»

2 Call the Language Filter Menu



Language Filter



- ① Selects a language.
- ② Searches for the selected language.
- ③ Returns to the DAB Tuner Menu.

3 Select a language you wish to use



◀ ▶

4 Search for the language



SRCH

Search for Program Type

The services are received when you set its program type.

1 Call the DAB Tuner Menu



Menu»

2 Call the PTY Search Menu



PTY Search



- ① Selects a program type.
- ② Searches for the program type.
- ③ Displays the Language select screen.
- ④ Returns to the DAB Tuner Menu.

3 Select a program type



Select a Language

Display the Language select screen



LANG



- ① Selects a Language.
- ② Searches for the program type.
- ③ Returns to the PTY Search Menu.

Select a Language



4 Search for the program type



SRCH

DAB Information

The DAB information is displayed.

1 Call the DAB Tuner Menu



Menu»

2 Display the DAB Information screen



DAB Information



- ① Displays the DAB information (such as Service label, Ensemble label, Component label, Audio quality, Region label, and Dynamic label).
- ② Scrolls the information display.
- ③ Returns to the DAB Tuner Menu.

DAB Announcement

When the Announcement you have turned on starts, any source is switched to the Announcement automatically.

When the announcement starts...

The Announcement screen appears automatically.

Announcement screen

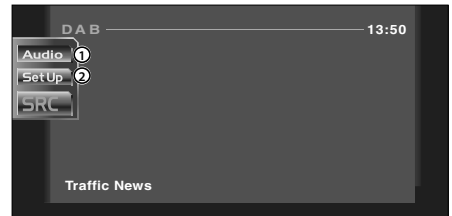

- ① Calls the Sound Effects Menu. (page 76)
- ② Calls the Setup Menu. (page 58)

Weather Band Tuner Control

Various control screens appear in the Weather Band Tuner source mode. (with the optional accessory Weather Band Tuner connected only)

Displaying the Easy Control Panel

The Weather Band Tuner Control Panel is displayed in a floating position of the selected picture.



Displaying the Easy Control Panel

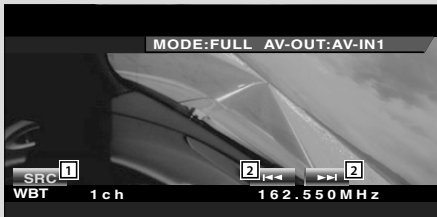

- 1 Switches the source.
- 2 Tunes in a station.



- For system key operations, see <DDX7017/7047 Basic Operations> (page 8).
- The Easy Control Panel display is hidden when you touch a central area of the monitor.

Displaying the Weather Band Tuner Control screen



Weather Band Tuner Control screen



- 3 Calls the Sound Effects Menu. (page 76)
- 4 Displays the Source Select screen. (page 56)
- 5 Calls the Setup Menu. (page 58)
- 6 Tunes in a station.

How To Use the Character Entry screen

When you select the Set Disc Name mode or others, the following screen appears for character entry.

Character Entry screen

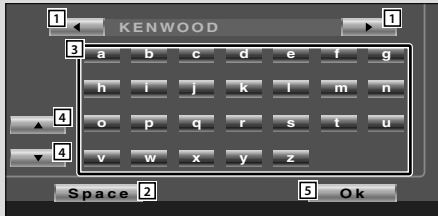

- 1 Shifts the cursor.
- 2 Enters a space.
If you erase a character, locate the cursor on it and touch this button.
- 3 Enters characters.
- 4 Scrolls up or down the character button display.
- 5 Exits the Character Entry mode and returns to the previous screen.



- You can enter characters only after you have applied the parking brake.

Source Select

The source you wish to listen to can be selected quickly.

Displaying the Control screen



Press this key several times until the Control screen appears.

Control screen



- The Source Select screen can be displayed from the control screen of any source

Displaying the Source Select screen



Source Select screen

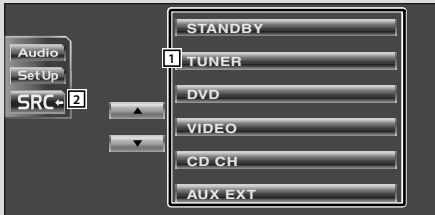

- 1 Select the source.
- 2 Returns to the Control screen previously displayed.

Adjusting the Monitor Display Position and Quality

You can adjust the position and picture quality of the monitor.

Displaying the Screen Control screen

You can adjust the picture quality using the following keys.



Screen Control screen

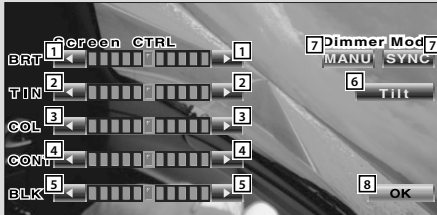

- 1 **Brightness Control**
- 2 **Tint Control**
Displayed for an NTSC system image on TV or Video.
- 3 **Color Control**
Displayed on the TV/Video screen only.
- 4 **Contrast Control**
- 5 **Black Level Adjustment**
- 6 Displays the Adjust Monitor Position screen.
(see <Displaying the tilt Adjust screen>, page 57)
- 7 **Dimmer Mode Setup**
"SYNC": Turning the Dimmer function On or Off when the vehicle light control switch is turned On or Off.
"MANU": Turning the Dimmer function On or Off when [SCRN] key is pressed more than 1 second.
- 8 Returns to the previous screen.



- The Screen Control screen is displayed only when you have applied the parking brake.
- The picture quality can be set for each source.

Displaying the Tilt Adjust screen

You can set the monitor position and open/close speed.



Tilt Adjust screen



- 9 **Monitor Tilt Adjustment**
- 10 The monitor fully closes.
- 11 Returns to the Screen Control screen.
- 12 Returns to the previous screen.



- If you turn the power off, the panel will close. However, if you turn the power back on, it will return to the adjusted tilt.

Setup Menu

Setup Menu

You can set up various receiver parameters.

Displaying the Control screen



Press this key several times until the Control screen appears.

Control screen



- You can call the same Setup Menu for the Control screen of each source.

Displaying the Setup Menu screen



Setup Menu screen

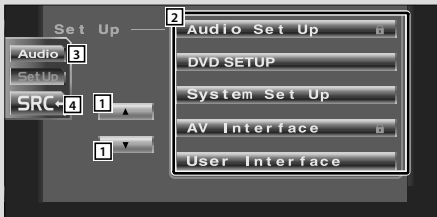

- 1 Scrolls the Setup Menu.
- 2 Calls each Setup Menu.
- 3 Calls the Sound Effects Menu. (page 76)
- 4 Returns to the Control screen of the previous source.



- Your setup on the Sound Effects menu is adjusted automatically according to your <Audio Set Up> (page 59) on the Setup menu. We recommend you to complete the <Audio Set Up> first, then set up the <Sound Effects menu>.
- The available functions vary depending on the model used (the tuner specifications and the broadcasting system that can be received).

Audio Set Up

You can setup a speaker network, etc.

Displaying the Audio Set Up screen



Audio Set Up

Speaker setup screen

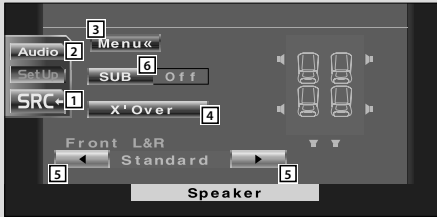

- 1 Returns to the Control screen of the previous source.
- 2 Calls the Sound Effects Menu. (page 76)
- 3 Calls the Setup Menu.
- 4 Displays the X'Over setup screen. (page 60)
- 5 Sets up the front speaker type to fine-tune for the optimal equalizer curves.
Standard: Setup for general diameter speakers
Narrow: Setup for small diameter speakers
Middle: Setup for middle diameter speakers
Wide: Setup for large diameter speakers
- 6 Set the use or no use of Subwoofer.

Crossover Network Setup

You can set a crossover frequency of speakers.



X'Over (Page 59 **4**)

X'Over setup screen



- ① Sets a Front High Pass Filter frequency.
You can select any of the following frequency.
Through, 40, 60, 80, 100, 120, 150, 180, 220 Hz
- ② Sets a Rear High Pass Filter frequency.
You can select any of the following frequency.
Through, 40, 60, 80, 100, 120, 150, 180, 220 Hz
- ③ Sets a Subwoofer Low Pass Filter frequency.
You can select any of the following frequency.
50, 60, 80, 100, 120, Through Hz
- ④ Sets the phase of subwoofer output.
The phase is reversed 180 degrees when set to "Reverse".
- ⑤ Returns to the Speaker setup screen.



- Set in both the front channel and rear channel simultaneously when using high pass filter function.
You cannot set a correct crossover network if the high pass filter function is only used for one channel.
- The SUB Phase button is not displayed when the Subwoofer Low Pass Filter is set to "Through".

DVD Setup

You can set up the DVD play.

Displaying the DVD SETUP 1 screen



DVD SETUP

DVD SETUP 1 screen



1 Returns to the Control screen of the previous source.

2 Calls the Sound Effects Menu. (page 76)

3 Calls the Setup Menu. (page 58)

4 Selects a disc menu language.*1
(See <Language Setup>, page 63)

5 Selects a subtitle language.*1
(See <Language Setup>, page 63)

6 Selects an audio language.*1
(See <Language Setup>, page 63)



7 Sets the dynamic range. (Wide)

The dynamic range is reduced by changing from "Wide" to "Normal" and from "Normal" to "Midnight". You can easily listen to a small sound when the dynamic range is narrow.

This is effective only when you are using a Dolby Digital software.

8 Displays the DVD SETUP 2 screen.



- If **DVD SETUP** is not shown, touch  or  to display it.
- *1 Disabled when a DVD is being played.

Displaying the DVD SETUP 2 screen



DVD SETUP 2 screen



- 9 Sets an angle mark display. (On)
- 10 Selects the screen display mode.*1 (16:9)
 - "16:9": Displays wide pictures.
 - "4:3 LB": Displays wide pictures in the Letter Box format (having black stripes at the top and bottom of screen).
 - "4:3 PS": Displays wide pictures in the Pan & Scan format (showing pictures cut at the right and left ends).
- 11 Displays the Parental Lock screen.*1 (Off)
(See <Parental Level Setup>, page 64)
- 12 Displays the DVD SETUP 1 screen.
- 13 Displays the DVD SETUP 3 screen.



- *1 Disabled when a DVD is being played.

Displaying the DVD SETUP 3 screen



DVD SETUP 3 screen



- 14 Selects a picture display time.*1 (Middle)
The Display of a JPEG picture is changed.
"Short", "Middle", "Long"
- 15 Selects the Picture Effect.*1 (Random)
- 16 Displays the DVD SETUP 2 screen.



- *1 Disabled when a DVD is being played.

Language Setup

Selects a language you use for the speech and menus.

1 Display the Language Setup screen

See <Displaying the DVD SETUP 1 screen> (page 61) and select a language you wish to use.



- ① Enters a language code.
- ② Cancels the language setup and returns to the DVD SETUP 1 screen.
- ③ Clears the language code.
- ④ Sets the original audio language.
(It appears during audio language setup.)
- ⑤ Sets the language and returns to the DVD SETUP 1 screen.
(It appears after you have entered a language code.)

2 Enter a language code

See the Language Code Table shown at right to select the desired language.

3 Set the language you use



Enter

Abbreviation	Language	Abbreviation	Language
aa	Afar	lv	Latvian, Lettish
ab	Abkhazian	mg	Malagasy
af	Afrikaans	mi	Maori
am	Amharic	mk	Macedonian
ar	Arabic	ml	Malayalam
as	Assamese	mn	Mongolian
ay	Aymara	mo	Moldavian
az	Azerbaijani	mr	Marathi
ba	Bashkir	ms	Malay
be	Byelorussian	mt	Maltese
bg	Bulgarian	my	Burmese
bh	Bihari	na	Nauru
bi	Bislama	ne	Nepali
bn	Bengali, Bangla	nl	Dutch
bo	Tibetan	no	Norwegian
br	Breton	oc	Occitan
ca	Catalan	om	(Afan) Oromo
co	Corsican	or	Oriya
cs	Czech	pa	Punjabi
cy	Welsh	pl	Polish
da	Danish	ps	Pashto, Pushto
de	German	pt	Portuguese
dz	Bhutani	qu	Quechua
el	Greek	rm	Rhaeto-Romance
en	English	rn	Kirundi
eo	Esperanto	ro	Romanian
es	Spanish	ru	Russian
et	Estonian	rw	Kinyarwanda
eu	Basque	sa	Sanskrit
fa	Persian	sd	Sindhi
fi	Finnish	sg	Sango
fj	Fiji	sh	Serbo-Croatian
fo	Faroese	si	Singhalese
fr	French	sk	Slovak
fy	Frisian	sl	Slovenian
ga	Irish	sm	Samoan
gd	Scots Gaelic	sn	Shona
gl	Galician	so	Somali
gn	Guarani	sq	Albanian
gu	Gujarati	sr	Serbian
ha	Hausa	ss	Siswati
he	Hebrew	st	Sesotho
hi	Hindi	su	Sundanese
hr	Croatian	sv	Swedish
hu	Hungarian	sw	Swahili
hy	Armenian	ta	Tamil
ia	Interlingua	te	Telugu
ie	Interlingue	tg	Tajik
ik	Inupiak	th	Thai
id	Indonesian	ti	Tigrinya
is	Icelandic	tk	Turkmen
it	Italian	tl	Tagalog
ja	Japanese	tn	Setswana
jv	Javanese	to	Tongan
ka	Georgian	tr	Turkish
kk	Kazakh	ts	Tsonga
kl	Greenlandic	tt	Tatar
km	Cambodian	tw	Twi
kn	Kannada	uk	Ukrainian
ko	Korean	ur	Urdu
ks	Kashmiri	uz	Uzbek
ku	Kurdish	vi	Vietnamese
ky	Kirghiz	vo	Volapuk
la	Latin	wo	Wolof
lb	Luxembourgish	xh	Xhosa
ln	Lingala	yo	Yoruba
lo	Laotian	zh	Chinese
lt	Lithuanian	zu	Zulu

Parental Level Setup

Sets a parental level.

1 Display the Parental Level code number screen



Set

(Page 62 )

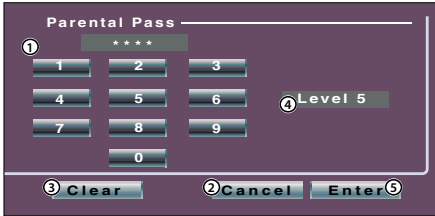

- ① Enters a code number.
- ② Cancels the current setup and returns to the DVD SETUP 2 screen.
- ③ Clears the code number.
- ④ Indicates the present parental lock level.
- ⑤ Determines the code number and displays the Parental Level Setup screen.

2 Enter the code number



0

9



- The number you enter first is set as your code number.
- You can clear the code number by pressing the Reset button.

3 Display the Parental Level Setup screen



Enter



- ① Sets a parental level.
- ② Returns to the DVD SETUP 2 screen.

4 Select a parental level



5 Complete the parental level setup



Return



- If a disc has a higher parental lock level, the audience needs to enter the code number.
- The parental lock level varies depending on a loaded disc.
- If a disc has no parental lock, any audience can play it back even when you have set the parental lock.

System Setup

You can set up the system parameters.

Displaying the System Set Up 1 screen



System Set Up

System Set Up 1 screen

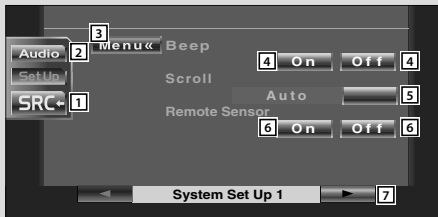

- 1 Returns to the Control screen of the previous source.
- 2 Calls the Sound Effects Menu. (page 76)
- 3 Calls the Setup Menu. (page 58)
- 4 Turns the key touch tone On or Off. (On)
- 5 Allows scrolling of text display on the Source Control screen. (Auto)
"Auto": Scrolls the screen automatically.
"Manual": Allows you to scroll the screen manually.
- 6 Selects a remote control signal. (On)
When turned "Off", the remote control of TV reception is rejected.
- 7 Displays the System Set Up 2 screen.



- If **System Set Up** is not shown, touch  or  to display it.

Displaying the System Set Up 2 screen



System Set Up 2 screen

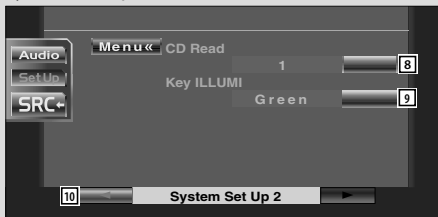

- 8 Sets a music CD playback. (1)
"1": Automatically recognizes and plays back an MP3/WMA disc, a DVD or a music CD.
"2": Forcibly plays back a disc as a music CD. Select "2" if you wish to play a music CD having a special format or if you cannot play a disc in the "1" position.



- You cannot play an MP3/WMA/VCD disc in the "2" position. Also, you may not play some music CDs in the "2" position.
 - Your setup is disabled when the disc is being played.
- 9 Selects an illumination color of receiver keys. (Red)
"Green": Green
"Red": Red
 - 10 Displays the System Set Up 1 screen.

AV Interface

You can set audio and visual (AV) interface parameters. <DDX7047 AV-IN (AV-IN1) only>

Displaying the AV I/F 1 screen



AV Interface

AV I/F 1 screen

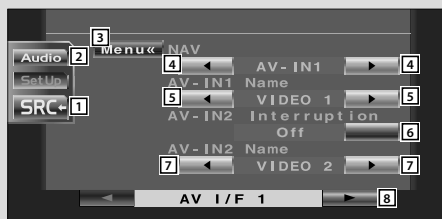

- 1 Returns to the Control screen of the previous source.
- 2 Calls the Sound Effects Menu. (page 76)
- 3 Calls the Setup Menu. (page 58)
- 4 Selects a navigation system connection. (RGB)
"RGB": Allows the Kenwood's Navigation System to connect via its interface cable.
"AV-IN1": Allows a third-party navigation system to connect via the AV INPUT1 port.
"Off": Must be used if no navigation system is connected. (The navigation display is cancelled when the AV source is switched.)
- 5 Sets a name to be displayed when you select a system that is connected via the AV INPUT1 port. (VIDEO1)



- If you have set the navigation system connection to "AV IN1", the display is fixed to "NAV".

- 6 Sets an image display of the system that is connected via the AV INPUT2 port. *1 (Off)
"Off": When the image source is switched, an image entered via the AV INPUT2 port is displayed.
"On": When an image signal is entered via the AV INPUT2 port, this image is displayed.
- 7 Sets a name to be displayed when you select an image of the system that is connected via the AV INPUT2 port. (VIDEO2) (Function of DDX7017)
- 8 Displays the AV I/F 2 screen.



- If AV Interface is not shown, touch ▲ or ▼ to display it.
- *1 This function can be use AV INPUT1. (DDX7047)

Displaying the AV I/F 2 screen



AV I/F 2 screen

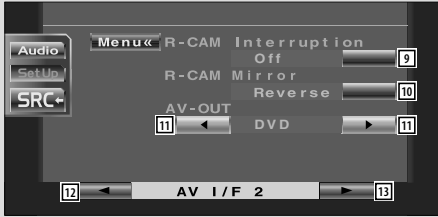

- 9 Sets a method to switch to the rear view camera video display. (🔍 Off)
"On": Switches to the rear view camera video display when engaging the shift knob of car to "Reverse".
"Off": Switches to the the rear view camera video display when engaging the shift knob of car to "Reverse" and then pressing the [V.SEL] switch several times.
- 10 You can flip the left and right of the rear view camera video display. Set to "Reverse" and the rear view will be displayed left and right in mirror image on the screen. (🔍 Normal)
- 11 Selects an AV source to be output at the AV OUTPUT port. (🔍 AV-IN1)
- 12 Displays the AV I/F 1 screen.
- 13 Displays the AV I/F 3 screen.

Displaying the AV I/F 3 screen



AV I/F 3 screen

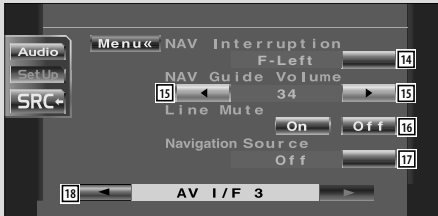

- 14 Selects speakers used for voice guidance of the navigation system. (🔍 F-Left)
"F-Left": Uses the front left side speaker for voice guidance.
"F-Right": Uses the front right side speaker for voice guidance.
"Front-All": Uses both front speakers for voice guidance.
- 15 Adjusts the volume for voice guidance of the navigation system. (🔍 19)
- 16 Mutes the volume during voice guidance of the navigation system. (🔍 On)
When turned "On", the volume level drops for voice guidance.
- 17 Sets a selecting method of audio source from the Navigation system. (🔍 Off)
"On": Allows you to select the audio source input from the Navigation system interface by pressing [SRC] or selecting it on Source Select screen.
"Off": The audio source cannot be selected using [SRC] or on Source Select screen.
- 18 Displays the AV I/F 2 screen.

User Interface

You can set up user interface (IF) parameters.

Displaying the User I/F 1 screen



User Interface

User I/F 1 screen

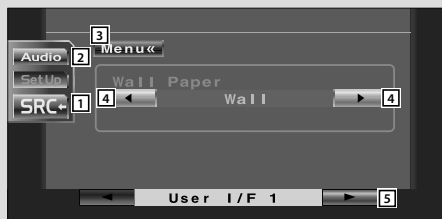

- 1 Returns to the Control screen of the previous source.
- 2 Calls the Sound Effects Menu. (page 76)
- 3 Calls the Setup Menu. (page 58)
- 4 Switches the wall paper.
- 5 Displays the User I/F 2 screen.



- If **User Interface** is not shown, touch  or  to display it.

Displaying the User I/F 2 screen



User I/F 2 screen

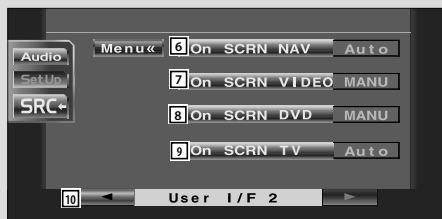

- 6 Sets an on-screen display of the navigation screen. (**Auto**)
 - "Auto": Information is displayed for 5 seconds when updated.
 - "Off": Information is not displayed.
- 7 Sets an on-screen display of the video playback screen. (**Auto**)
 - "Auto": Information is displayed for 5 seconds when updated.
 - "MANU": Information is displayed when you touch on the screen.
- 8 Sets an on-screen display of the DVD playback screen. (**MANU**)
 - "Auto": Information is displayed for 5 seconds when updated.
 - "MANU": Information is displayed when you touch on the screen.
- 9 Sets an on-screen display of the TV screen. (**Auto**) (with the optional accessory TV tuner connected only)
 - "Auto": Information is displayed for 5 seconds when updated.
 - "MANU": Information is displayed when you touch on the screen.
- 10 Displays the User I/F 1 screen.

Touch Panel Adjustment

You can adjust the touch panel operations.

1 Display the Touch Panel Adjust screen



If **Touch** is not shown, touch  or  to display it.



- ① Returns to the Control screen of the previous source.
- ② Calls the Sound Effects Menu. (page 76)
- ③ Calls the Setup Menu.
- ④ Allows you to start touch panel adjustment.

2 Start to adjust the touch panel

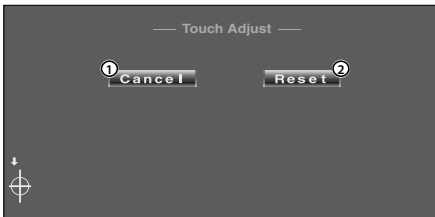

- ① Cancels the adjustment and returns to the Touch Panel Adjust screen.
- ② Resets to the initial status.

3 Adjust the positions



Touch the center of left lower and right upper  when requested.

Clock

You can adjust the clock time.

1 Display the Clock screen



If **Clock** is not shown, touch  or  to display it.

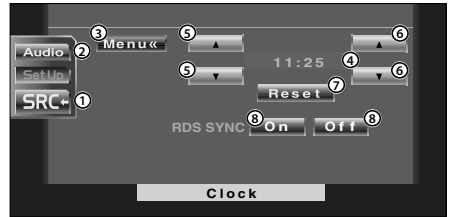

- ① Returns to the Control screen of the previous source.
- ② Calls the Sound Effects Menu. (page 76)
- ③ Calls the Setup Menu. (page 58)
- ④ Clock time display.
- ⑤ Adjusts hours.
- ⑥ Adjusts minutes.
- ⑦ Sets "00" minute.
Setup examples: 3:00~3:29 → 3:00
3:30~3:59 → 4:00
- ⑧ Sets the clock time in synchronization with the time data sent from the RDS station. (Off)
When turned "On", the synchronized mode starts and the clock cannot be adjusted manually.

2 Adjust the clock time



Security Code Setup

You can set a security code to protect your receiver system against theft.



- When the Security Code function is activated, the code cannot be changed and the function cannot be released. Note, the Security Code can be set as the 4 digit number of your choice.

1 Display the Security Code Setup screen



Security

If **Security** is not shown, touch **▲** or **▼** to display it.

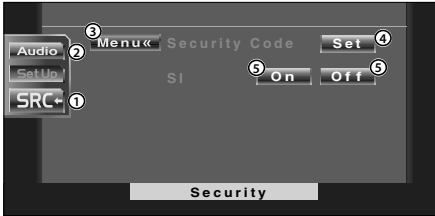

- Returns to the Control screen of the previous source.
- Calls the Sound Effects Menu. (page 76)
- Calls the Setup Menu. (page 58)
- Allows you to start security code registration.
- Turns the SI function On or Off.
If turned "On", the burglar alarm lamp flashes when the vehicle ignition is off. (🔧 On)



- If you have already completed the code registration, cannot touch **Set**.

2 Start the security code registration



Set

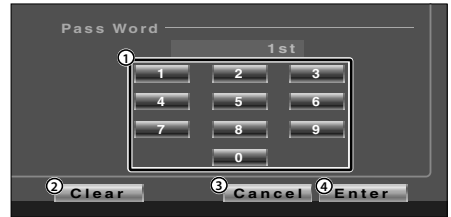

- Enters the numbers to make your security code.
- Clears your entry.
- Cancels the registration and returns to the Security Code Setup screen.
- Registers your security code.

3 Enter a security code



0 — **9**

Input by four-digit number.

4 Register your security code



Enter

5 Reenter the security code

Reenter the same security code as that you have entered in Step 3 for confirmation.



- If you enter a different security code, the screen returns to Step 3 (for the first code entry).

6 Register the security code again



Enter

Now, your security code is registered. If you press the Reset button or if you disconnect your receiver from the battery after the code registration, you need to enter the registered security code. See below for details.

If you have pressed the Reset button or if you have disconnected the Receiver from battery...

1 Enter the correct security code

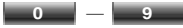

You must enter the same security code as that you have entered in Step 3 above.

2 Enter the security code



Now, you can use your Receiver.

Set Up Memory

Audio Set Up and AV Interface settings can be memorized. The memorized settings can be recalled at any time. For example, even when the settings are cleared due to replacement of the battery, the settings can be restored.

1 Display the Set Up Memory screen



Set Up Memory

If **Set Up Memory** is not shown, touch **▲** or **▼** to display it.

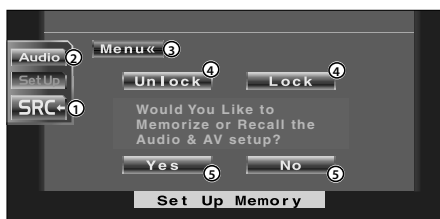

- ① Returns to the Control screen of the previous source.
- ② Calls the Sound Effects Menu. (page 76)
- ③ Calls the Setup Menu. (page 58)
- ④ Locks the Audio Set Up and AV Interface settings. When **Lock** is selected, you cannot set the Audio Set Up and AV Interface settings.
- ⑤ Memorizes or recalls the settings. To cancel the function, touch **No**.
To cancel memorization, touch **No**.
The Setup Menu screen appears again.

2 Display the Memory screen



Yes

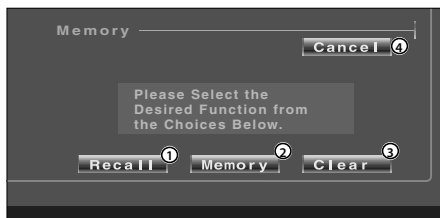

- ① Recalls the memorized settings.

- ② Memorizes the current Audio Set Up and AV Interface settings.
- ③ Clears the currently memorized settings.
- ④ Returns to Set Up Memory screen.

3 Memorize or recall the settings When memorizing the Audio Set Up and AV Interface settings:



Memory

If settings have already been memorized, a confirmation message appears. Touch **Yes**. To cancel memorization, touch **No**.

When recalling the memorized settings:



Recall

Touching the screen displays a confirmation message. Touch **Yes**. To cancel recalling, touch **No**.

When clearing the currently memorized settings:



Clear

Touching the screen displays a confirmation message. Touch **Yes**. To cancel clearing, touch **No**.

4 Quit memorization/recalling of settings



Cancel

SIRIUS Setup <North American sales only>

You can display the SIRIUS ID. (with the optional accessory SIRIUS Tuner connected only)

Displaying the SIRIUS Set Up screen



SIRIUS Set Up

SIRIUS Set Up screen

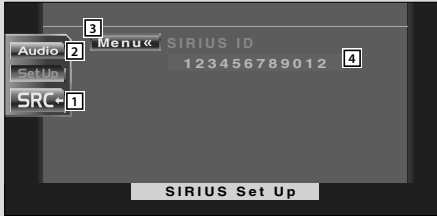

- 1 Returns to the Control screen of the previous source.
- 2 Calls the Sound Effects Menu. (page 76)
- 3 Calls the Setup Menu. (page 58)
- 4 Displays the SIRIUS ID



- If **SIRIUS Set Up** is not shown, touch  or  to display it.

DAB Set Up

You can set the DAB reception. (only with the optional accessory DAB Tuner connected)

Displaying the DAB Set Up screen



DAB Set Up

DAB Set Up screen

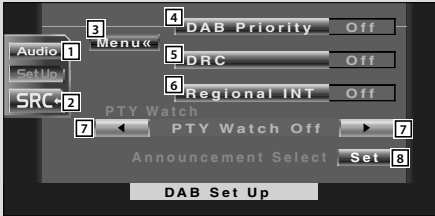

- 1 Calls the Sound Effects Menu. (page 76)
- 2 Returns to the Control screen of the previous source.
- 3 Calls the Setup Menu. (page 58)
- 4 Turns the DAB Priority On or Off.
- 5 Turns the Dynamic Range Control function On or Off.
- 6 Turns the Regional Announcement function On or Off.
- 7 Sets a program type to be selected automatically when the receiving ensemble starts.
- 8 Displays the Announcement Selection screen. (page 75)



- If **DAB Set Up** is not shown, touch  or  to display it.

Announcement Selection

You can set various announcement reception parameters.

1 Display the Announcement Selection screen



Set (Page 74 [8])



- ① Turns the Announcement Reception function On or Off.
- ② Scrolls the Announcement items.
- ③ Returns to the DAB Set Up screen.

2 Set the announcement parameters



Traffic News etc .

- "Traffic News": Traffic information
- "Transport News": Time table information of public transportation services
- "Warning": Lower priority items than alarms (power failure, cutoff of water supply and others)
- "News": News flash
- "Weather": Weather forecasting
- "Events": Event information
- "Special Events": Undetermined event information
- "Radio Info": Program information, advance notice
- "Sports News": Sports news
- "Financial News": Financial news

3 Terminate the setup



Return

Sound Effects Menu

Sound Effects Menu

You can set up the receiver sound effects.

Displaying the Control screen



Control screen



- You can display the same Sound Effects Menu on the Control screen of any source.

Displaying the Sound Effects Menu screen



Audio

Sound Effects screen



- 1 Calls the Sound Effects Menu.
- 2 Calls the Setup Menu. (page 58)
- 3 Returns to the Control screen of the previous source.



- Your setup on the <Sound Effects Menu> is adjusted automatically according to your <Audio Set Up> (page 59) on the Setup menu. We recommend you to complete the <Audio Set Up> first, then set up the <Sound Effects Menu>.

Audio Control

You can adjust the front/rear and right/left audio balance.

Displaying the Audio Control 1 screen



Audio Control

Audio Control 1 screen

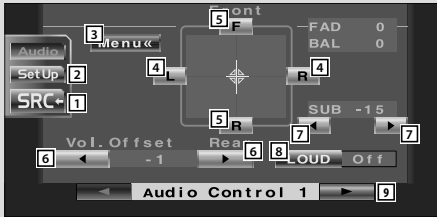

- 1 Returns to the Control screen of the previous source.
- 2 Calls the Setup Menu. (page 58)
- 3 Calls the Sound Effects Menu. (page 76)
- 4 Adjusts the right and left volume balance.
- 5 Adjusts the front and rear volume balance.
- 6 Adjusts the volume of the present source based on the difference level of original volume.



- If you have increased the volume first, then reduced the volume using the "Vol. Offset", the sound generated if you suddenly switch to another source may be extremely loud.
- 7 Adjusts the subwoofer volume.
 - 8 Turns the Loudness control function On or Off.
If turned "On", high and low tones are automatically enhanced during low volume. (On)
 - 9 Displays the Audio Control 2 screen.

Displaying the Audio Control 2 screen



Audio Control 2 screen



- 10 Adjusts the bass boost of the B.M.S power amplifier (optional accessory).



- You may not set some models of power amp boost to "+18". See the catalog or instruction manual of power amplifier.
- 11 Sets the center frequency of bass boost you have set for "AMP Bass".
If you set the center frequency to "Low", it will be dropped approximately 20% to 30%.
 - 12 Displays the Audio Control 1 screen.

Equalizer

You can set up the equalizer.

Displaying the Equalizer screen



Equalizer

Equalizer screen

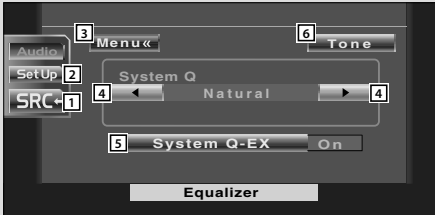

- 1 Returns to the Control screen of the previous source.
- 2 Calls the Setup Menu. (page 58)
- 3 Calls the Sound Effects Menu. (page 76)
- 4 Selects an equalizer curve type.
You can select any of the following equalizer curves.
 - "Natural"
 - "Rock"
 - "Pops"
 - "Easy"
 - "Top40"
 - "Jazz"
- 5 Selects items to be adjusted for tone curve setup.
If turned "Off", only Level can be setup for tone curves.
- 6 Displays the Tone curve setup screen. (page 79)

Tone curve setup

You can set a Tone curve.

1 Display the Tone setup screen



Tone setup screen



- ① Bass adjustment items are displayed.
- ② Middle adjustment items are displayed.
- ③ Treble adjustment items are displayed.
- ④ Bass DC Extend settings
If turned "On", it extends the bass center frequency to the low register by approximately 20%.
- ⑤ Tone curve becomes flat.
- ⑥ Returns to the Equalizer screen.



- Tone curve can be set for each source.

2 Select a frequency band you wish to adjust



You can adjust the following frequency bands.

Bass: 40, 50, 60, 70, 80, 100, 120, 150 Hz

Middle: 500, 1k, 1.5k, 2k Hz

Treble: 10k, 12.5k, 15k, 17.5k Hz

3 Set a center frequency



4 Set a level



5 Set a Q factor



You can set it up only when Bass or Middle is adjusted.

6 Close the Tone setup screen



Zone Control

You can set the front and rear audio source.

Displaying the Zone Control screen



Zone Control

Zone Control screen

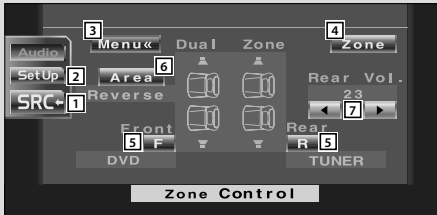

- 1 Returns to the Control screen of the previous source.
- 2 Calls the Setup Menu. (page 58)
- 3 Calls the Sound Effects Menu. (page 76)
- 4 Turns the Zone Function (that sets different source sounds for front and rear speakers) On or Off. When turned On, **F** and **R** are shown.
- 5 Sets the front and rear audio source separately. (This button appears when the Zone function is On.)



- When the rear speaker sound is switched, the audio source that is output at the AV OUTPUT terminal is also switched to the same source.

However, if you have set the "Area" to "Reverse", the audio source that is output at the AV OUTPUT terminal is switched depending on the front sound source.

- 6 Switches the front and rear audio sources. (This button appears when the Zone function is On.)
Use "Reverse" to change over the front and rear audio sources.
- 7 Adjusts the volume of the rear channel. (This button appears when the Zone function is On.)



- There are following limitations when zone function is set to "On".

- There is no output from the subwoofer or center.
- <Audio Set Up> (page 59) and <Equalizer> (page 78) are not available.

DVD: Digital Versatile Disc

A type of disc which contains recording of audio/video packaged media with high video and audio quality, such as a movie, featuring large recording capacity and digital signal processing capability.

VCD: VIDEO CD

A type of CD which contains the recording of moving images. It compresses image information by about 1/120 and audio information by about 1/6 and accommodates up to 74 minutes of recording in a disc with the same diameter as ordinary music CD of 12 cm.

Some VCDs do not have the P.B.C. compatibility and are capable of playback only, while some are P.B.C.-compatible and are capable of various special playback control operations. This player can play both of these VCDs.

MPEG: Moving Picture Experts Group

This is an international standard for digital video and audio compression and decompression in media.

Dolby Digital

This is a digital audio compression technology developed by Dolby Laboratories. It is compatible with 5.1-channel surround audio as well as normal stereo (2-channel) audio and can accommodate a large amount of audio data efficiently in a disc.

DTS

Name of a digital surround system developed by Digital Theater Systems, Inc.

Top menu/menu (DVD)

Some DVDs display more than one title in a screen. This screen is referred to as the top menu. The menu is the item display (menu screen) for use in setting operations. The menu can be recalled any time during playback to perform settings according to the current software, including the audio switching between Dolby Digital and PCM, switching of language used in the subtitles and spoken voice.

Title number (DVD)

The title is the largest unit of video and audio recorded in a DVD. It usually corresponds to a single movie of video software or an album (sometimes a piece of music) of music software. The numbers assigned to individual titles are referred to as the title numbers.

Chapter number (DVD)

The chapter is a section of video and audio recorded in a DVD. A title is composed of several chapters. The numbers assigned to individual chapters are referred to as the chapter numbers.

Subtitles (DVD)

Some DVD discs contains the recording of more than one subtitle language. This player allow you to select one of the recorded subtitle languages during playback.

Track number (CD, VCD)

A track is also a section of video and audio recorded in a disc. The numbers assigned to individual tracks are referred to as the track numbers.

With most of music CDs, a track is assigned to a piece of music. However, with a VCD, the sections of the contents do not always correspond to the assigned tracks.

As (special) playback functions such as skipping and programming of ordinary CDs are based on track number data, such playback functions are sometimes impossible with some VCDs.

P.B.C.: Play-Back Control (VCD)

When a VIDEO CD carries "Play Back Control capable" or similar message on the disc or jacket, desired scenes and information can be played back in an interactive manner using a hierarchical structure while viewing the menu screens displayed on the TV screen.

Troubleshooting Guide

What might appear to be a malfunction in your unit may just be the result of slight misoperation or miswiring. Before calling service, first check the following table for possible problems.

General

? The power does not turn on.

- ✓ The fuse has blown.
- ✘ After checking for short circuits in the wires, replace the fuse with one having the same rating.
- ✓ The speaker wire has a short-circuit or touches the chassis of the vehicle, and then the protection function is activated.
- ✘ Wire or insulate the speaker cable properly and press the reset button.

? The desired source is NOT selected although you pressed the SRC button.

- ✓ A non-connected source cannot be selected.
- ✘ A non-connected source is not selected. See <INSTALLATION MANUAL> and connect the unit correctly.
- ✓ The RESET button is not pressed yet although the optional unit has been connected to the system.
- ✘ Press the reset button (page 4).
- ✓ The "O-N" switch of the optional unit is at the "O" position.
- ✘ Set the "O-N" switch to the "N" position.
- ✓ A disc changer not supported by the system is used.
- ✘ Use a disc changer supported by the system (page 4).

? Nothing happens when the buttons are pressed.

- ✓ The computer chip in the unit is not functioning normally.
- ✘ Press the reset button on the unit (page 4).

? The message "Disconnected cable found. Please confirm a connection line" is displayed and the unit cannot be used.

- ✓ Receiver unit is disconnected.
- ✘ Connect the wire correctly, referring to the section on <INSTALLATION MANUAL>.

? No television/video image appears.

- ✓ The unit is not connected to the parking brake detection switch.
- ✘ Make proper connections according to <INSTALLATION MANUAL>.

- ✓ The parking brake is not engaged.
- ✘ For safety reasons no television/video images are displayed while the vehicle is moving. Engaging the parking brake will cause images to be displayed.

? The screen is dark.

- ✓ The unit is in a location where temperature is low.
- ✘ If the temperature of the monitor unit drops, the screen may appear darker when power is first turned on due to the characteristics of a liquid crystal panel. Wait a while after turning power on for the temperature to rise. Normal brightness will return.

? The screen does not darken when the vehicle's lights are turned on.

- ✓ The unit is set to auto dimmer.
- ✘ When the unit is set to auto dimmer, it is not linked to the vehicle's light switch.
- ✓ The illumination wire has not been connected. (If manual dimmer is set)
- ✘ Make proper connections according to <INSTALLATION MANUAL>.

? AM/FM radio reception is poor and/or there is noise.

- ✓ The TV antenna and vehicle's radio antenna are too close.
- ✘ Separate the two antennas as far as possible.
- ✘ Turn off the main unit.

? The remote controller does not operate.

- ✓ The remote control mode selector is not set correctly.
- ✘ Switch the remote control mode selector according to the source you select (page 10).

? No sound can be heard, or the volume is low.

- ✓ Attenuator is turned on.
- ✘ Turn off Attenuator.
- ✓ The fader or balance settings are set all the way to one side.
- ✘ Reset the fader and/or balance settings.
- ✓ The input/output wires or wiring harness are connected incorrectly.
- ✘ Reconnect the input/output wires or the wiring harness correctly. See the section on <INSTALLATION MANUAL>.

? The sound quality is poor or distorted.

- ✓ One of the speaker wires is being pinched by a screw in the car.
 - ✘ Check the speaker wiring.

 - ✓ The speakers are not wired correctly.
 - ✘ Reconnect the speaker wires so that each output terminal is connected to a different speaker.
-

? Radio reception is poor.

- ✓ The car antenna is not extended.
 - ✘ Pull the antenna out all the way.

 - ✓ The antenna control wire is not connected.
 - ✘ Connect the wire correctly, referring to the section on <INSTALLATION MANUAL>.
-

? The memory is erased when the ignition is turned off.

- ✓ The battery wire has not been connected to the proper terminal.
 - ✘ Connect the wire correctly, referring to the section on <INSTALLATION MANUAL>.

 - ✓ The ignition and battery wire are incorrectly connected.
 - ✘ Connect the wire correctly, referring to the section on <INSTALLATION MANUAL>.
-

? The sound/picture skips on a DVD/VCD/CD.

- ✓ The disc is scratched or dirty.
 - ✘ Clean the disc, referring to the section on <Disc cleaning> (page 13).
-

? Does not switch to the rear view camera video display when pressing the [V.SEL] button.

- ✓ The reverse sensor wire is disconnected.
 - ✘ Connect the wire correctly, referring to the section on <INSTALLATION MANUAL>.
-

? A track will not play.

- ✓ Random play has been selected.
 - ✘ Turn off random play.
-

? A VCD cannot be played using menus.

- ✓ The VCD disc being played is not compatible with P.B.C.
 - ✘ Menu playback is available only with VCD discs recorded with P.B.C.
-

? The subtitle is not displayed.

- ✓ The DVD disc being played does not contain the recording of subtitles.
 - ✘ The subtitle cannot be displayed when the DVD disc being played does not contain the recording of subtitles.
-

? The voice (or subtitle) language cannot be changed.

- ✓ The DVD disc being played does not contain the recording of more than one audio (or subtitle) language.
 - ✘ The voice (or subtitle) language cannot be changed when the DVD disc being played does not contain the recording of more than one voice (or subtitle) language.
-

? The viewing angle cannot be changed.

- ✓ The DVD disc being played does not contain the recording of more than one angle.
 - ✘ The viewing angle cannot be changed when the DVD disc being played does not contain the recording of more than one angle.

 - ✓ You are attempting to switch the angle in a DVD section where more than one angle is not recorded.
 - ✘ More than one viewing angle may be recorded only in limited sections in a disc.
-

? Playback will not start even after a title is selected.

- ✓ A viewing restriction (RATING) has been set for the disc.
 - ✘ Check the viewing restriction level (RATING) setting.
-

? The voice or subtitle language selected in the initial setting is not played.

- ✓ The DVD disc being played does not contain the recording of the selected voice or subtitle language.
 - ✘ Use a DVD disc containing the recording of the selected voice or subtitle language.
-

Disc source

? The disc control mode cannot be selected.

- ✓ No wire has been connected to the disc changer input terminal on the unit.
- ✘ Connect the wire to the disc changer input terminal on the unit.

? The specified disc does not play, but another one plays instead.

- ✓ The specified CD is quite dirty.
- ✘ Clean the CD.
- ✓ The CD is upside-down.
- ✘ Load the CD with the labeled side up.
- ✓ The disc is loaded in a different slot from that specified.
- ✘ Eject the disc magazine and check the number for the specified disc.
- ✓ The disc is severely scratched.
- ✘ Try another disc instead.

? The sound skips.

- ✓ Something is touching the disc changer.
- ✘ Remove whatever is touching it.
- ✓ The CD is scratched or dirty.
- ✘ If skipping happens at the same place when the car is stopped, something with the CD is wrong. Clean the CD.

? The display shows that the changer is being played, but no sound can be heard.

- ✓ The computer chip in the unit is not functioning normally.
- ✘ Press the reset button on the unit (page 4).

? The specified track will not play.

- ✓ Random play or magazine random play has been selected.
- ✘ Turn off random play or magazine random play.

? Track repeat, disc repeat, track scan, disc scan, random play, and magazine random play start by themselves.

- ✓ The setting is not cancelled.
- ✘ The settings for these functions remain on until the setting to off or the disc ejected, even if the power is turned off or the source changed.

? Can not remove disc.

- ✓ The cause is that more than 10 minutes has elapsed since the vehicle ACC switch was turned OFF.
- ✘ The disc can only be removed within 10 minutes of the ACC switch being turned OFF. If more than 10 minutes has elapsed, turn the ACC switch ON again and press the Eject button.

MP3/WMA source

? Cannot play an MP3/WMA.

- ✓ The media is scratched or dirty.
- ✘ Clean the media, referring to the Disc cleaning of the section on <About discs> (page 13).

? The sound skips when an MP3/WMA is being played.

- ✓ The media is scratched or dirty.
- ✘ Clean the media, referring to the Disk cleaning of the section on <About discs> (page 13).
- ✓ The recording condition is bad.
- ✘ Record the media again or use another media.

? The MP3/WMA track time is not displayed correctly.

- ✓ ---
- ✘ There are times when it isn't displayed correctly according to the MP3/WMA recording conditions.

? Can not display the ID3 tag information correctly.

- ✓ Record is not made in conformity with the ID3 tag version 1.x.
 - ✘ Record in conformity with the ID3 tag version 1.x.
- Also, the display may be incorrect if an MP3/WMA file uses the ID3 tag v1.x standard and if this standard has been expanded after production of the machine software.

The following messages are displayed when certain problems are occurring in your system. Take the recommended actions.

Hot Error

The protection circuit in the unit activates when the temperature inside the unit exceeds 60°C (140°F), stopping all operation.

⇒ Cool down the unit by opening the windows or turning on the air conditioner. As the temperature falls below 60°C (140°F), the disc will start playing again.

Hold Error

The protection circuit in the unit activates when the temperature inside the automatic disc changer exceeds 60°C (140°F), stopping all operation.

⇒ Cool down the unit by opening the windows or turning on the air conditioner. As the temperature falls below 60°C (140°F), the disc will start playing again.

Mecha Error

The disc player is malfunctioning.

⇒ Eject the disc and try inserting it again. Contact the Kenwood dealer if this indicator continues blinking or the disc cannot be ejected.

Disc Error

The unplayable discs is inserted.

Read Error

The disc is upside-down.

⇒ Load the disc with the labeled side up.

The disc is quite dirty.

⇒ Clean the disc, referring to the section on <Disc cleaning> (page 13).

Region code Error

The DVD software encoded for other region code.

Parental level Error

The parental level is set to high levels.

Error 07 — 67

The unit is malfunctioning for some reason.

⇒ Press the reset button on the unit. If the "Error ##" code does not disappear, consult your nearest service center.

Specifications

Specifications subject to change without notice.

Monitor section

- Picture size
 - : 6.4 inches (diagonal) wide
 - 143.6(W)×77.1(H)mm
- Display system
 - : Transparent TN LCD panel
- Drive system
 - : TFT active matrix system
- Number of pixels
 - : 336,960 (480H×234V×RGB)
- Effective pixels
 - : 99.99%
- Pixel arrangement
 - : RGB striped arrangement
- Back lighting
 - : Cold Cathode Fluorescent Tube

DVD section

- D/A Converter
 - : 24Bit
- Decoder
 - : Linear PCM/Dolby Digital/dts/MP3/WMA
- Wow & Flutter
 - : Below Measurable Limit
- Frequency response
 - Sampling frequency;96k: 20~22,000Hz
 - Sampling frequency;48k: 20~22,000Hz
 - Sampling frequency;44.1k: 20~20,000Hz
- Total harmonic distortion (1k)
 - : 0.007%
- Signal to Noise ratio
 - : 98dB (DVD 96k)
- Dynamic range
 - : 98dB (DVD 96k)
- DISC Format
 - : DVD-Video/MDEO-CD/CD-DA
- Sampling frequency
 - : 44.1kHz/48kHz, 96kHz
- Quantifying bit number
 - : 16/20/24bit

FM Tuner section

- Frequency range (200kHz)
 - : 87.9~107.9MHz
- Usable sensitivity (S/N=30dB)
 - : 9.3dBf (0.8μV/75Ω)
- Quieting sensitivity (S/N=50dB)
 - : 15.2dBf (1.6μV/75Ω)
- Frequency response (±3.0dB)
 - : 30Hz~15kHz
- S/N (dB) (MONO)
 - : 70dB
- Selectivity (±400kHz)
 - : ≥ 80dB
- Stereo separation
 - : 40dB (1kHz)

AM Tuner section

- Frequency range (10kHz)
 - : 530kHz~1700kHz
- Usable sensitivity
 - : 28dBμ

Video section

- Color system of external video input
 - : NTSC
- External video input level (RCA jacks)
 - : 1Vp-p/75Ω
- External audio max input level(RCA jacks)
 - : 1V/22kΩ
- Analog RGB input
 - : 0.7Vp-p/75Ω

Audio section

- Maximum Power (Front&Rear)
 - : 50W×4
- Full Bandwidth Power (Front&Rear)(at Less than 1%THD)
 - : 22W×4
- Preout level (V)
 - : 5V/10kΩ
- Preout impedance
 - : 80Ω
- Tone action
 - Bass: 100 Hz ±10 dB
 - Middle: 1 kHz ±10 dB
 - Treble: 10 kHz ±10 dB

General

- Operating voltage
 - : 14.4V (11V~16V)
- Current consumption
 - : 15A
- Dimensions (W×H×D)
 - : 182 ×112 ×163mm
 - 7-3/16×4-7/16×6-7/16inch
- Operational temperature range
 - : -10°C~60°C
- Storage temperature range
 - : -20°C~85°C
- Weight
 - : 2.9kg (6.4lbs)

Although the effective pixels for the liquid crystal panel is given as 99.99% or more, 0.01% of pixels may not light or may light incorrectly.

CAUTION

Use of controls or adjustments or performance of procedures other than those specified herein may result in hazardous radiation exposure.

In compliance with Federal Regulations, following are reproductions of labels on, or inside the product relating to laser product safety.

KENWOOD CORPORATION
2967-3, ISHIKAWA-MACHI,
HACHIOJI-SHI
TOKYO, JAPAN

KENWOOD CORP. CERTIFIES THIS EQUIPMENT
CONFORMS TO DHHS REGULATIONS NO.21 CFR
1040.10, CHAPTER 1, SUBCHAPTER J.

Location : Bottom Panel

FCC WARNING

This equipment may generate or use radio frequency energy. Changes or modifications to this equipment may cause harmful interference unless the modifications are expressly approved in the instruction manual. The user could lose the authority to operate this equipment if an unauthorized change or modification is made.

NOTE

This equipment has been tested and found to comply with the limits for a Class B digital device, pursuant to Part 15 of the FCC Rules. These limits are designed to provide reasonable protection against harmful interference in a residential installation. This equipment may cause harmful interference to radio communications, if it is not installed and used in accordance with the instructions. However, there is no guarantee that interference will not occur in a particular installation. If this equipment does cause harmful interference to radio or television reception, which can be determined by turning the equipment off and on, the user is encouraged to try to correct the interference by one or more of the following measures:

- Reorient or relocate the receiving antenna.
- Increase the separation between the equipment and receiver.
- Connect the equipment into an outlet on a circuit different from that to which the receiver is connected.
- Consult the dealer or an experienced radio/TV technician for help.

NOTE

This Class B digital apparatus complies with Canadian ICES-003.



is a trademark of DVD Format/Logo Licensing Corporation registered in the U.S., Japan and other countries.

This product incorporates copyright protection technology that is protected by U.S. patents and other intellectual property rights. Use of this copyright protection technology must be authorized by Macrovision, and is intended for home and other limited viewing uses only unless otherwise authorized by Macrovision. Reverse engineering or disassembly is prohibited.

Manufactured under license from Dolby Laboratories.
"Dolby" and the double-D symbol are trademarks of Dolby Laboratories.

"DTS" and "DTS 2.0 + Digital Out" are trademarks of Digital Theater Systems, Inc.

KENWOOD